



Jersey

# **TRAFFIC SIGNS (JERSEY) ORDER 1968<sup>1</sup>**

## **Official Consolidated Version**

This is an official version of consolidated legislation compiled and issued under the authority of the Legislation (Jersey) Law 2021.

Showing the law from 17 May 2021 to 21 April 2026



Jersey

## TRAFFIC SIGNS (JERSEY) ORDER 1968

### Contents

#### Article

<b>PART 1</b>	<b>5</b>
PRELIMINARY	5
1 Interpretation .....	5
<b>PART 2</b>	<b>6</b>
TRAFFIC SIGNS IN SCHEDULE 1	6
2 Signs to be of the sizes, colours and types shown in Schedule 1 .....	6
3 Permitted variants .....	6
4 Dimensions .....	7
5 Proportions and form of letters and numerals .....	7
6 Illumination of signs .....	7
7 Placing and fixing, and colour of the backs, of signs shown in Schedule 1 .....	8
8 Use of signs .....	9
9 Significance of sign shown in diagram No. 601.1 .....	10
10 Variable message signs .....	10
<b>PART 3</b>	<b>11</b>
TRAFFIC SIGNS IN SCHEDULE 2	11
11 Road markings to be of the sizes and types shown in Schedule 2 .....	11
12 Road marking shown in diagram no. 1003 .....	11
13 Road marking shown in diagram no. 1013 .....	11
14 Colour of road markings .....	12
15 Use of reflecting material and studs with reflectors on road markings .....	13
16 Height of road markings .....	13
17 Placing and use of road markings .....	13
<b>PART 4</b>	<b>14</b>
MISCELLANEOUS TRAFFIC SIGNS	14
18 Yellow line .....	14
19 Significance of yellow line .....	14

20	Certain temporary signs .....	14
21	Flashing beacons.....	15
22	Flags .....	16
23	Cones .....	16
24	Light signals .....	16
25	Portable light signals .....	17
26	Significance of light signals.....	18
27	Hazard warning lights .....	19
28	Light signals for pedestrians.....	19
28A	Part-time speed limits at schools .....	20
<b>PART 5</b>		<b>20</b>
GENERAL		20
29	Variations in dimensions shown in diagrams .....	20
30	Exceptions for drivers of vehicles used for emergency services.....	21
31	Citation .....	21
<b>SCHEDULE 1</b>		<b>22</b>
PART 1		22
WARNING SIGNS		22
PART 2		29
REGULATORY SIGNS		29
PART 3		38
DIRECTIONAL INFORMATORY SIGNS		38
PART 4		43
OTHER INFORMATORY SIGNS		43
PART 5		47
SIGNS FOR PEDAL CYCLE FACILITIES		47
<b>SCHEDULE 2</b>		<b>50</b>
MARKINGS ON THE ROAD		50
<b>SCHEDULE 3</b>		<b>69</b>
INCORPORATION OF ARROW IN LIGHT SIGNALS FOR VEHICULAR TRAFFIC		69
<b>SCHEDULE 4</b>		<b>70</b>
PROPORTION AND FORM OF LETTERS, NUMERALS AND OTHER CHARACTERS		70
PART 1		70
TRANSPORT MEDIUM CAPITAL ALPHABET FOR USE ON SIGNS WITH A RED, BLUE OR GREEN BACKGROUND		70
PART 2		71

TRANSPORT MEDIUM LOWER-CASE ALPHABET FOR USE ON SIGNS WITH A RED, BLUE OR GREEN BACKGROUND	71
PART 3	71
TRANSPORT MEDIUM NUMERALS FOR USE ON SIGNS WITH A RED, BLUE OR GREEN BACKGROUND	71
PART 4	72
TRANSPORT MEDIUM OTHER CHARACTERS FOR USE ON SIGNS WITH A RED, BLUE OR GREEN BACKGROUND	72
PART 5	72
TRANSPORT HEAVY CAPITAL ALPHABET FOR USE ON SIGNS WITH A WHITE OR YELLOW BACKGROUND	72
PART 6	73
TRANSPORT HEAVY LOWER-CASE ALPHABET FOR USE ON SIGNS WITH A WHITE OR YELLOW BACKGROUND	73
PART 7	74
TRANSPORT HEAVY NUMERALS FOR USE ON SIGNS WITH A WHITE OR YELLOW BACKGROUND	74
PART 8	74
TRANSPORT HEAVY OTHER CHARACTERS FOR USE ON SIGNS WITH A WHITE OR YELLOW BACKGROUND	74
<b>ENDNOTES</b>	<b>75</b>
Table of Legislation History.....	75
Table of Renumbered Provisions .....	76
Table of Endnote References .....	77



Jersey

## TRAFFIC SIGNS (JERSEY) ORDER 1968<sup>2</sup>

**THE ENVIRONMENT AND PUBLIC SERVICES COMMITTEE**, in pursuance of Articles 72 and 84 of the [Road Traffic \(Jersey\) Law 1956](#), orders as follows –

Commencement [[see endnotes](#)]

### PART 1

#### PRELIMINARY

#### 1 Interpretation

(1) In this Order –

“an approved organisation” means the Royal Automobile Club or the Automobile Association;

“contra-flow” means part of a road where traffic or a specified class of traffic is authorized to proceed in the opposite direction to other traffic on that road;

“cycle lane” means a part of a road which starts with the marking shown in diagram 1009 and is separated from the rest of the road by the marking shown in diagram 1004 or 1049;

“hours of darkness” means the time between half-an-hour after sunset and half-an-hour before sunrise;

“island-wide speed limit” means the speed specified in Schedule 2 to the Law as the maximum speed in relation to a vehicle of the class or description there specified;

“Law” means the [Road Traffic \(Jersey\) Law 1956](#);

“non-primary route” means a route which is not a primary route;

“primary route” means a route formed by roads which have been designated by the Minister for Infrastructure as roads important for the proper and effective circulation of traffic;

“road hump” means an artificial hump in or on the surface of the highway which is designed to control the speed of vehicles;

“traffic controller” has the same meaning as in Article 74(5) of the Law;

“with-flow” in relation to a lane of traffic means a lane reserved for a specified class of traffic proceeding in the same direction as general traffic in an adjoining lane.<sup>3</sup>

- (2) Any reference in this Order to a diagram number is, except where otherwise expressly provided, a reference to that diagram number in Schedule 1 or 2 and any reference to any sign includes any variation thereof permitted by this Order.
- (3) Any reference in this Order to a numbered Schedule is, except where otherwise expressly provided, a reference to the Schedule bearing that number in this Order.

## **PART 2**

### **TRAFFIC SIGNS IN SCHEDULE 1**

#### **2 Signs to be of the sizes, colours and types shown in Schedule 1**

Subject to the provisions of this Order, a traffic sign for conveying –

- (a) to vehicular traffic on roads a warning of the description specified in or under a diagram set out in Part 1 of Schedule 1 shall be of the size, colour and type shown in the diagram relating to that warning;
- (b) to vehicular traffic on roads a requirement, prohibition or restriction specified in or under a diagram set out in Part 2 of Schedule 1 shall be of the size, colour and type shown in the diagram relating to that requirement, prohibition or restriction;
- (c) to traffic on roads information of a directional nature of the description specified in or under a diagram set out in Part 3 of Schedule 1 shall be of the size, colour and type shown in the diagram relating to that information;
- (d) to traffic on roads information of the description specified in or under a diagram set out in Part 4 of Schedule 1 shall be of the size, colour and type shown in the diagram relating to that information.

#### **3 Permitted variants**

- (1) Where the circumstances so require, the indications given by the signs shown in Schedule 1 shall or may be varied as follows –
  - (a) any indication given by such a sign may be varied in the respect (if any) in which it is shown below the diagram relating to that sign that the indication may be varied;
  - (b) in the signs shown in diagrams Nos. 557.2, 557.3, 570, 571, 572, 626, 629 and 630 the numerals shall be varied to accord with the circumstances;
  - (c) in the signs shown in diagrams Nos. 639, 640, 640.2J, 641 and 807 the legend, and in the sign shown in diagram No. 662 and 663 the legend and colour shall be varied to accord with the prohibition or restriction imposed in relation to vehicular traffic;
  - (d) in the signs shown in diagrams Nos. 515, 557.3, 557.4, 568, 569, 606 (through 180 degrees above horizontal), 639, 640, 644 and 810 the direction of any arrow or chevron shown therein shall be varied to accord with the circumstances, and in the signs in diagrams Nos. 639 and 640 the arrows may

be omitted and in the sign in diagram No. 641 an arrow pointing in the appropriate direction left or right may be included;

- (e) in the signs shown in diagrams Nos. 570 to 572 any distance shown therein may be expressed in yards or miles as is appropriate and in the sign shown in diagram No. 563 an indication of distance may be expressed as is appropriate;
  - (f) in the signs shown in diagrams Nos. 713, 724, 728, 732, 733, 735, 736, 740 and 742 the direction in which they point may be reversed;
  - (g) in the signs shown in diagrams Nos. 704, 705, 713, 715, 718, 720, 724, 727, 728, 730 to 733, 736, 737J, 740 and 742 the appropriate route numbers, place names, route symbols, arrows and distances shall be varied having regard to the place where any such sign is erected except that in the sign shown in diagram No. 724 the mileage may be omitted.<sup>4</sup>
- (2) Where overall dimensions are shown in Schedule 1 for any such sign as is mentioned in paragraph (1) of this Article and the sign is varied in accordance with that paragraph, the overall dimensions may be varied insofar as is necessary to give effect to that variation.

#### **4 Dimensions**

- (1) Where as respects any diagram in Schedule 1 a dimension for the sign shown in the diagram is indicated in one or more sets of brackets against a dimension not indicated in brackets, any dimension indicated in a set of brackets may be treated as an alternative to the dimension not so indicated.
- (2) A sign shown in a diagram in Part 3 of Schedule 1 (other than in diagram No. 717) shall be of such dimensions having regard to the character of the road and the speed of the vehicular traffic generally using it as are necessary to accommodate any place name, route symbol, route number, arrow, any indication of distance, or any other indication which in accordance with this Order may be shown therein and it is appropriate to show for the purpose for which the sign is placed on a road.

#### **5 Proportions and form of letters and numerals**

All letters incorporated in the signs shown in the diagrams in Schedule 1 shall have the proportions and form shown in either Part 1, Part 2, Part 5 or Part 6 of Schedule 4, all numerals incorporated in the signs shown in the diagrams in Schedule 1 shall have the proportions and form shown in Part 3 or Part 7 of Schedule 4 and all other characters incorporated in the signs shown in the diagrams in Schedule 1 shall have the proportions and form shown in Part 4 or Part 8 of Schedule 4.

#### **6 Illumination of signs**

- (1) The signs shown in diagrams Nos. 557.1, 560 and 561 in Part 1 of Schedule 1 and every sign shown in a diagram in Part 2 of that Schedule shall be illuminated by the use of the reflecting material in accordance with the provisions of paragraphs (4) and (5):

Provided that this paragraph shall not apply to any sign which is so illuminated by street lighting throughout the hours of darkness as to be legible from a reasonable distance by drivers of approaching vehicles.<sup>5</sup>

- (2) Any sign shown in a diagram in Parts 1 (other than diagrams Nos. 560 and 561), 3 and 4 of Schedule 1, and any sign shown in a diagram in Part 2 of Schedule 1 to which the proviso to paragraph (1) applies, may be illuminated by the use of reflecting material in accordance with the provisions of paragraphs (4) and (5).
- (3) Where a sign shown in a diagram in Schedule 1 (not being a sign consisting of a plate) is illuminated by the use of reflecting material in accordance with the provisions of this Article and a plate shown in a diagram in that Schedule is used in conjunction with that sign, the said plate shall be illuminated by the use of reflecting material in accordance with the provisions of paragraph (4).
- (4) Subject to the provisions of paragraph (5), where reflecting material is used on any sign shown in a diagram in Schedule 1 it shall be of the same colour as that of, and extend throughout, that part of the sign to which it is applied:  
  
Provided that no reflecting material shall be applied to any part of a sign coloured black.
- (5) Where in accordance with paragraph (4) different colours of reflecting material are used immediately adjacent to one another on the same sign, a gap of not more than  $\frac{3}{4}$  of an inch in width but not less than  $\frac{1}{4}$  of an inch in width may be left between the different colours of reflecting material.

## **7 Placing and fixing, and colour of the backs, of signs shown in Schedule 1**

- (1) Signs shown in diagrams Nos. 606 (except when erected on the central island of a roundabout or when used in combination with a plate of the type shown in diagram No. 608), 607, 609 (except when used in combination with a plate of the type shown in diagram No. 608), 612 to 614, 616 to 622, 624, 625, 625.4J, 626, 627, 629, 630, 632, 636, 637, 639 to 645, 661, 670.1J, 671.1J, 801 (when used in combination with a plate of the type shown in diagram No. 662, 663 or 805 indicating restriction on the use of a parking place) and 806 to 810 may be placed on or near a road only to indicate the effect of any enactment which prohibits or restricts the use of a road by vehicular traffic.<sup>6</sup>
- (2) The sign shown in diagram No. 560 or 561 shall be so placed that the top of the sign is not less than 2 feet 6 inches nor more than 4 feet 6 inches above the surface of the carriageway in the immediate vicinity.
- (3) Where the sign shown in diagram No. 560 or 561 is mounted on a post specially provided for the purpose, that part of the post which extends above ground level shall be coloured black and white in alternate horizontal bands, each band being not less than 9 inches nor more than 13 inches in depth.
- (4) The signs shown in diagrams Nos. 704, 705, 713, 715 and 717 may be placed only on or near a primary route and the signs shown in diagrams Nos. 718, 720 and 724 (and 715 when the colour of the background is varied as shown beneath the diagram) may be placed only on or near a non-primary route.
- (5) Where a sign shown in a diagram in Schedule 1 is mounted on a post specially provided for the purpose, that part of the post which extends above ground level shall be coloured grey except –
  - (a) in a case where different provision as to the colouring of the post is made by this Article;

- (b) in a case where the post is constructed of concrete and, in such a case, it shall remain in its natural colour; or
  - (c) in a case where the post is not likely to be readily visible to pedestrians and, in such a case, the post shall be coloured grey but with one white band of 6 inches in depth, the lower edge of the band being between 5 feet and 5 feet 6 inches above the level of the surface of the ground in the immediate vicinity.
- (6) The back of any sign shown in a diagram in Schedule 1 and any fitting provided for the assembly of such a sign, including any container enclosing apparatus for the illumination of the sign, shall be coloured –
- (a) black, if the sign is mounted on the same post as that on which light signals for the control of vehicular traffic as prescribed by this Order are mounted; and
  - (b) grey, in any other case.

## 8 Use of signs

- (1) The sign shown in diagram No. 562 may be used only in combination with a plate of the type shown in diagram No. 563.
- (2) The signs shown in diagrams Nos. 564, 565, 567, 568 and 569 may be used only in connection with the execution of works on or near a road or a temporary obstruction thereon and any such sign so used and any other sign shown in a diagram in Schedule 1 used on or near a road in connection as aforesaid shall not be retained on or near a road after the completion of the works or the removal of the obstruction, as the case may be.
- (3) The sign shown in diagram No. 601.1 may be used on a road only in conjunction with both the road markings shown in diagrams Nos. 1002.1 and 1022, the sign shown in diagram No. 602 may be used on a road only in conjunction with the sign specified in Article 18(1) or with the road marking shown in diagram No. 1003 and the sign shown in diagram No. 611.1 may be used on a road only in conjunction with both the road markings shown in diagrams Nos. 1003.3 and 1003.4:

Provided that the provisions of this paragraph shall not apply during the execution of works on a road in the vicinity of the place where the sign shown in diagram No. 601.1 or in diagram No. 602 or in diagram No. 611.1 is erected if those works necessitate the temporary removal of the sign or road marking in conjunction with which it is used and shall not apply if the said sign is erected only temporarily in connection with the execution of works on a road.<sup>7</sup>

- (4) The signs shown in diagrams Nos. 603 and 604 may be used only where one-way traffic working is necessary owing to a temporary closure to vehicular traffic of a width of the carriageway of a road.
- (5) The signs shown in diagrams Nos. 615 and 811 may be used only in conjunction with one another.
- (6) The sign shown in diagram No. 617 may be used only in combination with a plate of the type shown in diagram No. 618J.
- (7) The signs shown in diagrams Nos. 833 to 836 may be used only to regulate the movement of vehicular traffic into and out of premises with more than one access to a road.

- (8) A plate of the type shown in diagram No. 511, 518, 546, 563, 570, 571, 572, 602AJ, 607, 608, 616A, 618J, 620, 627, 643, 644, 645, 661.1, 662, 663, 805 or 807 may be used only in combination with the signs which are specified beneath the diagram showing the plate.<sup>8</sup>

## 9 Significance of sign shown in diagram No. 601.1<sup>9</sup>

- (1) The requirements conveyed by the sign shown in diagram No. 601.1 shall be that –
- (i) every vehicle shall stop before crossing the transverse line shown in diagram No. 1002.1 or, if that line is not clearly visible, before entering the major road in respect of which the sign shown in diagram No. 601.1 has been provided;
  - (ii) no vehicle shall proceed beyond the transverse line shown in diagram No. 1002.1 or, if that line is not clearly visible, enter the major road in respect of which the sign shown in diagram No. 601.1 has been provided, so as to be likely to cause danger to the driver of any other vehicle on the major road or to cause that driver to change the speed or course of the driver's vehicle so as to avoid an accident.
- (2) In this Article –
- “major road” means the road at a road junction into which there emerges vehicular traffic from a minor road;
- “minor road” means a road at a junction on which road there is placed the sign shown in diagram No. 601.1.

## 10 Variable message signs<sup>10</sup>

- (1) A device may display at different times –
- (a) a sign or combination of signs shown in a diagram in Schedule 1; or
  - (b) a blank grey or a blank black face,
- and shall be referred to as a “variable message sign”.
- (2) A variable message sign shall be of a size appropriate to display the messages referred to in paragraph (1)(a), having regard to the normal speed of traffic on the road on or near which the sign is situated.
- (3) Subject to paragraph (4), if the construction or method of operation of a variable message sign prevents the sign from being displayed in the colours shown for it in the appropriate diagram in Schedule 1, a black legend or symbol on a white background may be displayed as a white, off-white or yellow legend or symbol on a dark background provided that the red circle forming part of the sign is retained.
- (4) Any symbol which is part of a variable message sign may be displayed intermittently at a rate of flashing of not less than 60 nor more than 150 flashes per minute.

## PART 3

### TRAFFIC SIGNS IN SCHEDULE 2

#### 11 Road markings to be of the sizes and types shown in Schedule 2

- (1) Subject to the provisions of this Order, a traffic sign consisting of a line or mark on a road (in this Order referred to as a “road marking”) for conveying a warning, a requirement or information of the description specified under a diagram (other than diagrams Nos. 1003 and 1013) set out in Schedule 2 shall be of the size and type shown in the diagram relating to that warning, requirement or information.
- (2) Where as respects any diagram in Schedule 2 a dimension for the marking shown in the diagram is indicated in one or more sets of brackets against a dimension not indicated in brackets, any dimension indicated in a set of brackets may be treated as an alternative to the dimension not so indicated.<sup>11</sup>

#### 12 Road marking shown in diagram no. 1003

- (1) For the purposes of this Article –
  - (a) “minor road” means a road at a road junction at which there is a roundabout, on which road are placed the transverse lines shown in diagram No. 1003 and the signs shown in diagrams Nos. 602 and 602AJ;
  - (b) “major road” means the road at a road junction into which road emerges vehicular traffic from a minor road.
- (2) A road marking for conveying to vehicular traffic the requirement specified in paragraph (3) shall be of the size and type shown in diagram No. 1003.
- (3) The requirement conveyed by the transverse lines shown in diagram No. 1003 shall be taken as according preference to vehicular traffic using or about to use a major road and as requiring any person driving a vehicle on a minor road, before passing such one of the said transverse lines on the minor road as is nearest to the major road, to ensure that the vehicle may enter the major road in such a manner or at such time as is not likely to cause danger to the driver of any other vehicle on the major road or about to enter the major road from another minor road to the right, or to necessitate the driver of any such other vehicle to change its speed or course in order to avoid an accident with the first-mentioned vehicle.

#### 13 Road marking shown in diagram no. 1013

- (1) A road marking for conveying the requirements specified in paragraph (2) and the warning specified in paragraph (5) shall be of the size and type shown in diagram No. 1013.
- (2) The requirements conveyed by the road marking shown in diagram No. 1013 shall be taken –
  - (a) subject to the provisions of paragraph (3), as prohibiting vehicles from stopping on any length of road along which the marking has been placed at any point between the 2 ends of the marking; and

- (b) subject to the provisions of paragraph (4), as requiring every vehicle proceeding on any length of road, along which the marking has been so placed that, as viewed in the direction of travel of the vehicle, the continuous line is on the left of a dotted line or a continuous line, to be driven as to keep the first mentioned continuous line on the right hand or off-side of the vehicle.
- (3) Nothing in paragraph (2)(a) shall apply –
- (a) so as to prevent a vehicle stopping on any length of road so long as may be necessary –
    - (i) to enable a person to board or to alight from the vehicle,
    - (ii) to enable goods to be loaded on to or unloaded from the vehicle, or
    - (iii) to enable the vehicle, if it cannot be used for such purpose without stopping on that length of road, to be used in connection with any building operation or demolition, the removal of any obstruction to traffic, the maintenance, improvement or reconstruction of that length of road, or the laying, erection, alteration or repair in or near to that length of road of any sewer or of any main, pipe or apparatus for the supply of gas, water, electricity, or of any telegraphic line;
  - (b) to a vehicle used for fire service, ambulance or police purposes;
  - (c) to a pedal cycle not having a side car attached thereto, whether additional means of propulsion by mechanical power are attached to the bicycle or not;
  - (d) to a vehicle stopping owing to the driver being prevented from proceeding by circumstances beyond his or her control or to such stopping being necessary in order to avoid an accident; or
  - (e) to anything done with the permission of a police officer.
- (4) Nothing in paragraph (2)(b) shall apply so as to prevent a vehicle crossing or straddling the continuous line first mentioned in that sub-paragraph for the purpose of obtaining access to any other road joining the length of road along which the line is placed or to land or premises situated on or adjacent to the said length of road or if it is necessary to do so –
- (a) in order to pass a stationary vehicle, or owing to circumstances beyond the control of the driver or to avoid an accident; or
  - (b) for the purpose of complying with any direction of a police officer.
- (5) The warning conveyed by the road marking shown in diagram No. 1013 shall be that no vehicle while travelling next to a dotted line placed on the left, as viewed in the direction of travel of the vehicle, of a continuous line should cross or straddle the first mentioned line unless it is seen by the driver of the vehicle to be safe to do so.

## **14 Colour of road markings**

- (1) Save as provided by paragraph (2), the road markings shown in Schedule 2 shall be white.
- (2) The road markings shown in diagrams Nos. 1016J, 1017, 1018J, 1021J 1023, 1043 and 1044 shall be yellow.<sup>12</sup>

**15 Use of reflecting material and studs with reflectors on road markings**

- (1) Subject to paragraph (3), any road marking shown in a diagram in Schedule 2 may be illuminated with reflecting material and studs incorporating reflectors may be fitted to any such marking.<sup>13</sup>
- (2) Reflectors incorporated in studs shall be red or white.
- (3) The road marking shown in diagram Nos. 1060, 1060.1, 1061 and 1061.1 shall be illuminated with reflecting material.<sup>14</sup>

**16 Height of road markings**

- (1) The road markings shown in Schedule 2 shall not project above the surface of the carriageway in the immediate vicinity more than one quarter of an inch.
- (2) Studs incorporating reflectors fitted to any road marking may project above the surface of the carriageway in the immediate vicinity by not more than 1 inch at their highest points.

**17 Placing and use of road markings**

- (1) Road markings shown in diagrams Nos. 1016J, 1017, 1018J, 1021J, 1022J, 1029, 1036, 1037, 1043, 1044, 1049.1J and 1057 may be placed on a road only to indicate the effect of any enactment which prohibits or restricts the use of a road by vehicular traffic.<sup>15</sup>
- (2) The road marking shown in diagram No. 1001 may be placed on a road only in conjunction with the light signals prescribed by Article 24 or where traffic may be controlled by a traffic controller.
- (3) The road markings shown in diagrams Nos. 1002.1 and 1022 may be placed on a road only in conjunction with the sign shown in diagram No. 601.1; and the road markings shown in diagrams Nos. 1003.3 and 1003.4 shall be placed on a road only in conjunction with the sign shown in diagram No. 611.1.<sup>16</sup>
- (4) The road marking shown in diagram No. 1016J may be placed on a side of a road only to indicate that stopping by vehicular traffic on that side is prohibited along the length of the marking constituting such sign.
- (5) The road marking shown in diagram No. 1017 may be placed on a side of a road only to indicate that waiting by vehicular traffic on that side is prohibited along the length of the line constituting such sign.
- (6) The road marking shown in diagram No. 1021J may be placed on a road only in conjunction with a sign of the type shown in diagram No. 661.<sup>17</sup>
- (7) The road marking shown in diagram No. 1022J may be placed on a road only in conjunction with a sign of the type shown in diagram No. 606, 609, 612, 613, 616 or 617.
- (8) The road marking shown in diagram No. 1023 may be placed on a road only in conjunction with the sign specified in Article 18(1).

## PART 4

### MISCELLANEOUS TRAFFIC SIGNS

#### 18 Yellow line

- (1) For the purposes of this Article, the Minister for Infrastructure may determine, in relation to any junction of roads, which of those roads are to be treated as major roads and which as minor roads, and save as provided by paragraph (4), may cause to be placed on the carriageway of every minor road in close proximity to such a junction a traffic sign, consisting of a transverse line, yellow in colour, measuring not less than 8 inches and not more than 10 inches in width, and not less than 5 feet in length.<sup>18</sup>
- (2) Lines placed on the carriageway of a road in pursuance of paragraph (1) may be illuminated with reflecting material and may be fitted with studs, incorporating red reflecting lenses, such studs being of a type approved by the Minister for Infrastructure and so placed as not to project above the surface of the carriageway in the immediate vicinity more than 5/8 of an inch at their highest point nor more than 1/4 of an inch at their edges.<sup>19</sup>
- (3) Where any minor road is a main road, the Minister for Infrastructure may cause to be erected on the road a sign of the type shown in diagram No. 602, which sign shall be erected at a distance of not less than 10 yards nor more than 25 yards from the junction so as to be clearly visible to vehicular traffic approaching the junction.<sup>20</sup>
- (4) The provisions of paragraphs (1) and (3) shall not apply in relation to –
  - (a) any junction of roads at which light signals prescribed by Article 24 have been installed;
  - (b) any junction of roads to which Article 9 applies; or
  - (c) any junction of roads at which there is a roundabout and at which signs of the type shown in diagrams Nos. 602 and 602AJ and a road marking of the type shown in diagram No. 1003 have been erected,and no such line or sign as is mentioned in the said paragraphs (1) and (3) shall be placed at such a junction.<sup>21</sup>

#### 19 Significance of yellow line

The significance of a traffic sign placed in pursuance of Article 18(1) shall be taken as according preference to vehicular traffic using a major road and as requiring any person driving a vehicle on a minor road to proceed slowly when approaching such sign and, before passing the sign, to ensure that the vehicle may safely enter the major road:

Provided that such a sign shall have no significance at any place where vehicular traffic is for the time being subject to control by a traffic controller.

#### 20 Certain temporary signs

- (1) Notwithstanding the provisions of Article 2 and subject to the following provisions of this Order, signs placed temporarily on or near a road –
  - (a) for conveying to traffic –

- (i) information as respects deviations of, or alternative, traffic routes,
  - (ii) information as respects the route which may conveniently be followed on the occasion of a sports meeting, exhibition or other public gathering, in each case attracting a considerable volume of traffic, or
  - (iii) a warning of works being executed on or near a road or any obstruction on a road; or
- (b) pending the erection of any permanent sign prescribed by this Order for conveying to traffic the indication which such a permanent sign indicates;
- shall be of such size, colour and type as is specified in the following provisions of this Article.
- (2) Every such sign as aforesaid (hereinafter referred to as a “temporary sign”) shall be of a shape which –
- (a) is rectangular;
  - (b) is rectangular, but with the corners rounded; or
  - (c) is rectangular, but with one end pointed.
- (3) Every temporary sign shall be of such size as is necessary to accommodate the wording, numerals and arrows or chevrons appropriate to the purpose for which it is placed as aforesaid and any arms, badge, device, words or letters incorporated in the sign in accordance with the provisions of paragraph (6).
- (4) Every letter and numeral incorporated in a temporary sign, other than any letter incorporated in a sign in accordance with the provisions of paragraph (6), shall be not less than 1½ inches nor more than 10 inches in height, and every arrow so incorporated shall be not less than 10 inches nor more than 36 inches in length except that where an arrow is incorporated in the index part of a sign with a pointed end such arrow shall be not less than 4 inches nor more than 8 inches in length.
- (5) Every letter, numeral, arrow or chevron incorporated in a temporary sign shall be –
- (a) black in colour on a background of white, silver or yellow; or
  - (b) white or silver in colour on a background of red or blue.
- (6) There may be incorporated in or attached to a temporary sign the arms, badge or other device of a highway authority or an approved organization or words or letters indicating the highway authority or that the sign is a police sign.
- (7) No sign shall by virtue of this Article convey to traffic any warning, requirement, restriction or prohibition of a description which can be so conveyed either by a sign shown in Part 1 or Part 2 of Schedule 1 or by a sign so shown used in combination with or in conjunction with another sign shown in such a diagram.

## 21 Flashing beacons

- (1) Beacons showing an intermittent red or amber light for conveying the warning that drivers of vehicles should take special care may be used in combination with or in conjunction with any of the signs specified in Article 20 or with any of the signs shown in diagrams Nos. 562 to 565 and 567 to 569, subject to the following conditions –

- (a) the dimensions of the lenses shall be not less than 5 inches nor more than 8 inches measured in a straight line in any direction;
  - (b) the height of the centre of the lenses from the surface of the carriageway in the immediate vicinity shall be not less than 4 feet nor more than 8 feet;
  - (c) the number of flashes shall be not less than 50 nor more than 100 per minute; and
  - (d) the structure, if any, on which the beacons are supported shall be coloured black and white in alternate sloping bands.
- (2) Beacons showing an intermittent blue light for conveying the warning that drivers of vehicles should take special care may be used in combination with or in conjunction with either of the signs shown in diagrams Nos. 634 and 635 subject to the same conditions specified in paragraph (1).

## 22 Flags

Flags of an area of not less than 2 feet square and coloured red for conveying the warning that it would be dangerous for drivers to cause their vehicles to proceed may be used in an emergency at or in the vicinity of works being executed on or near a road:

Provided that during the hours of darkness flags shall not be used as aforesaid unless they are so illuminated by lighting as to be clearly visible to approaching traffic.

## 23 Cones

A device constructed of rubber or flexible plastic material and being of a cone shape for conveying the warning that drivers of vehicles should follow a certain route round an obstruction or road works in a road may be placed temporarily on the carriageway thereof subject to the following conditions –

- (a) the height of the device shall be not more than 2 feet 6 inches nor less than 1 foot 6 inches;
- (b) the lowermost part of the device (excluding the base) to a height of 2 inches and the uppermost part of the device to a depth of not less than one quarter nor more than one third of the height thereof shall be coloured red, and the remainder of the device shall be coloured white;
- (c) that part of the device coloured white shall be illuminated with white reflecting material and that part of the device coloured red may be illuminated with red reflecting material.

## 24 Light signals

- (1) Light signals may be used for the control of vehicular traffic subject to the following provisions –
- (a) 3 lights shall be used facing the stream of traffic which the signal is intended to control, one red, one amber and one green;
  - (b) the lamps showing the coloured lights aforesaid shall be arranged vertically, the lamp showing a red light being the uppermost and that showing a green light the lowermost;

- (c) each lamp shall be separately illuminated and the effective diameter of the lens thereof shall be between 8 inches and 8¼ inches or between 12 inches and 12¼ inches;
  - (d) the height of the centre of the green lens from the surface of the carriageway in the immediate vicinity shall be not less than 7 feet 4 inches nor more than 7 feet 9 inches, except that, where desirable owing to road gradients, the height may be increased to not more than 10 feet;
  - (e) the centre of the lenses shall be not more than 14 inches apart;
  - (f) the head of a signal enclosing the lamps shall be coloured black and the post, if any, on which it is supported shall be coloured black and white in alternate horizontal bands or grey;
  - (g) the word “STOP” in black lettering may be placed on the lens of the lamp showing a red light and no other lettering shall be used on the lenses or in connection with a light signal;
  - (h) the sequence of the signal lights shown for the purpose of controlling vehicular traffic shall be as follows –
    - (i) red,
    - (ii) green,
    - (iii) amber.<sup>22</sup>
- (2) Subject to the provisions of paragraph (4), a lens of the size and colour shown in diagram No. 1 in Schedule 3 which, when illuminated, shows a green arrow –
- (a) may be substituted for the lens showing the green light in the light signals referred to in paragraph (1) in any of the methods shown in diagrams Nos. 4 to 8 in the said Schedule 3; or
  - (b) may be affixed to the light signals referred to in the said paragraph (1), or to those signals as altered in accordance with sub-paragraph (a) of this paragraph, in any of the methods shown in diagrams Nos. 2, 3, 6, 7 and 8 in the said Schedule 3.
- (3) Subject to the provisions of paragraph (4), the direction in which any arrow shown in any of the diagrams Nos. 4 to 8 in Schedule 3 points may be varied so as to be –
- (a) a direction which lies straight upright; or
  - (b) a direction which lies between the direction shown in the diagram showing the arrow and the said upright direction.
- (4) A lens of the size and colour shown in diagram No. 1 in Schedule 3 may only be fitted to the light signals referred to in paragraph (1) of this Article in any of the methods shown in diagrams Nos. 4 to 8 in the said Schedule 3 where vehicular traffic controlled by the signals is restricted by virtue of any enactment to proceeding in the direction indicated by the arrow shown in such lens or the directions indicated by the arrows where 2 such lenses are fitted.

## 25 Portable light signals

- (1) Portable light signals may be used for the control of vehicular traffic –

- (a) where, owing to road works being in progress or for some other reason, the width of the carriageway is temporarily restricted so that it will carry only one line of traffic; or
  - (b) during the progress of temporary schemes of traffic control, if the signals are in the control of the police.
- (2) Such light signals shall comply either with the provisions of Article 24(1) (a), (b), (c), (e), (g) and (h) and paragraph (3) (d) and (f) of this Article or with all of the provisions of the said paragraph (3).
- (3)
- (a) Two lights shall be used facing the stream of traffic which the signal is intended to control, one red and the other green;
  - (b) the lamps showing the coloured lights aforesaid shall be arranged vertically, the lamp showing a red light being uppermost;
  - (c) each lamp shall be separately illuminated and the effective diameter of the lens thereof shall be not less than 8 inches nor more than 8¼ inches;
  - (d) the height of the centre of the green lens from the surface of the carriageway in the immediate vicinity shall be not less than 5 feet nor more than 11 feet 6 inches;
  - (e) the centres of the lenses shall not be more than 28 inches apart;
  - (f) the head of the signal enclosing the lamps shall be coloured black and the post or legs on which it is supported shall be coloured black and white in alternate horizontal bands;
  - (g) the word “STOP” in black lettering shall be placed on the lens of the lamp showing a red light and, where the signals are in the control of the police, appropriate words indicating that the signals are police signals may be used; and
  - (h) the red and green lights shall not be shown together and one shall follow the other without any appreciable interval of time.

## 26 Significance of light signals

- (1) The significance of the light signals prescribed by Article 24 or 25 shall be as follows –
- (a) the red signal shall be taken as prohibiting vehicular traffic from proceeding beyond the stop line on the carriageway provided in conjunction with the signals or, if that line is not for the time being visible or there is no stop line, beyond the signals;
  - (b) the green signal shall be taken to indicate that vehicular traffic may proceed;
  - (c) any green arrow during such time as it is illuminated shall be taken to indicate that vehicular traffic may pass the signals and proceed only in the direction indicated by the arrow notwithstanding any other indication given by the signals;
  - (d) the amber signal (when provided) shall be taken as prohibiting vehicular traffic from proceeding beyond the stop line or, if that line is not for the time being visible or there is no stop line, beyond the signals, except in the case of

any vehicle which, when the signal first appears, is so close to the stop line or signals that it cannot safely be stopped before passing the line or signals.

- (2) Vehicular traffic passing any light signals in accordance with the foregoing provisions of this Article shall proceed with due regard to the safety of other users of the road and subject to the direction of any traffic controller.
- (3) In this Article, “stop line” means the sign shown in diagram No. 1001.

## **27 Hazard warning lights<sup>23</sup>**

A light signal, consisting of 2 lamps each showing an intermittent amber light used in combination or in conjunction with the sign shown in diagram No. 545, for conveying the warning that drivers of vehicles should take special care in relation to the hazard depicted in the diagram shall fulfil the following conditions –

- (a) the signal shall be used facing the stream of traffic which it is intended to warn;
- (b) the lamps shall be arranged vertically so that the distance between the centre of the lenses shall be one foot 6 inches;
- (c) each lamp shall be separately illuminated;
- (d) the effective diameter of the lens of each lamp shall be 5½ inches;
- (e) the height of the base of the signal enclosing the lamps from the surface of the carriageway in the immediate vicinity shall be 6 feet 6 inches;
- (f) each lamp shall show its intermittent amber light at a rate of flashing of 80 flashes every 2 minutes, and in such a manner that the light of one lamp is always shown when the light of the other lamp is not shown;
- (g) the head of the signal enclosing the lamps shall be coloured black.

## **28 Light signals for pedestrians**

- (1) Light signals indicating to pedestrians the period during which it is desirable that they should cross the carriageway may be used in conjunction with the light signals prescribed in Article 24 and, if so used, shall consist of –
  - (a) a lamp facing across the carriageway which, when lit, illuminates the words “CROSS” or “CROSS NOW” in white or green letters on a black background;
  - (b) 2 lamps arranged vertically with their centres not more than 28 inches apart and facing across the carriageway, the upper lamp of which, when lit, shows a red light or illuminates the word “WAIT” in red letters and the lower lamp of which, when lit, illuminates the words “CROSS” or “CROSS NOW” in white or green letters on a black background; or
  - (c) 2 lamps arranged vertically and facing across the carriageway, the upper lamp of which, when lit, shows in red on a black background the figure of a standing pedestrian, and the lower lamp of which, when lit, shows in green on a black background the figure of a walking pedestrian.<sup>24</sup>
- (2) The head of the signal enclosing the lamps shall be coloured black and the post, if any, on which it is supported shall be coloured black and white in alternate horizontal bands.

**28A Part-time speed limits at schools<sup>25</sup>**

- (1) The sign shown in diagram 670.1J –
  - (a) is the sign placed to indicate the presence of a part-time speed limit at a school in accordance with the [Road Traffic \(Speed Limits\) \(Jersey\) Order 2003](#); and
  - (b) shall display the light signal shown in the diagram whenever the speed limit displayed on the sign applies in accordance with that Order.<sup>26</sup>
- (2) Each lamp of the light signal of the sign shall, when operated, show an intermittent amber light at a rate of flashing of neither less than 60 nor more than 90 flashes per minute and in such a manner that one light is always shown when the other light is not.
- (3) The sign shown in diagram 671.1J shall be displayed at the end of each section of carriageway to which the speed limit mentioned in paragraph (1)(b) applies.

**PART 5****GENERAL****29 Variations in dimensions shown in diagrams**

- (1) Any variation in a dimension (other than as to the height of a letter) specified in any of the diagrams in Schedule 1 or Schedule 3 shall be treated as permitted by this Order if the variation –
  - (a) in the case of a dimension so specified as 12 inches or as over 12 inches, does not exceed 2½% of that dimension;
  - (b) in the case of a dimension so specified as 2 inches or as over 2 inches but as under 12 inches, does not exceed 5% of that dimension; or
  - (c) in the case of a dimension so specified as under 2 inches, does not exceed 10% of that dimension.
- (2) Any variation in a dimension as to the height of a letter specified in any of the diagrams in Schedule 1 shall be treated as permitted by this Order if the variation –
  - (a) in the case of a dimension so specified as 4 inches or as over 4 inches, does not exceed 2½% of that dimension; or
  - (b) in the case of a dimension so specified as under 4 inches, does not exceed 5% of that dimension.
- (3) Any variation in a dimension (other than a dimension expressed in diagrams Nos. 1043 and 1044 as being the maximum or, as the case may be, minimum) specified in any of the diagrams in Schedule 2 shall be treated as permitted by this Order if the variation –
  - (a) in the case of a dimension so specified as 10 feet or as over 10 feet, does not exceed 5% of that dimension;
  - (b) in the case of a dimension so specified as 1 foot or as over 1 foot but under 10 feet, does not exceed 10% of that dimension; or
  - (c) in the case of a dimension so specified as under 1 foot, where the actual dimension exceeds the dimension so specified, does not exceed 20% of the

dimension so specified, and where the actual dimension is less than the dimension so specified, does not exceed 10% of the dimension so specified.<sup>27</sup>

### **30 Exceptions for drivers of vehicles used for emergency services<sup>28</sup>**

A person shall not be convicted of an offence under Article 74(1) of the Law for failure to conform to the indication given by –

- (a) any of the signs shown in diagram Nos. 602, 603, 606, 609, 610, 613, 614, 615, 616, 617, 618J, 619, 622, 632, 636, 642, 811, 812, 813, 828J, 833, 834, 835, 836, 1001, 1003, 1016J, 1017, 1022J, 1024, 1026, 1036, 1037, and 1038;
- (b) a light signal described in Article 24 or Article 25; or
- (c) a traffic sign placed in pursuance of Article 18(1),

if the person proves to the satisfaction of the Court the matters set out in Article 74(3) (a), (b) and (c) of the Law.

### **31 Citation**

This Order may be cited as the Traffic Signs (Jersey) Order 1968.

**SCHEDULE 1**

**PART 1<sup>29</sup>**

**WARNING SIGNS**

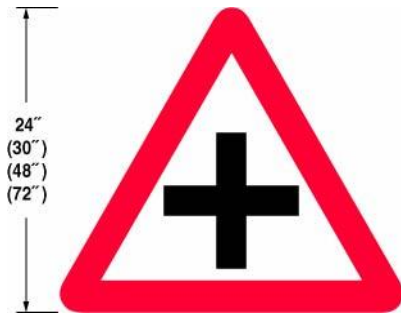

**Cross Roads**  
**504**



**T junction**  
**505**



**Side road**  
Permitted variant: The  
symbol may be reversed  
**506**



**Staggered junction**  
Permitted variant: The  
symbol may be reversed  
**507**



**Traffic merges**  
**508**



**Same as 508**  
**509**



Roundabout  
**510**



Plate for use with signs in diagrams  
Nos. 510, 512, 513, 514, 516, 517,  
520, 544, 545 and 548,  
(See Article 8)  
**511**



Bend to the right  
Permitted variant: The  
symbol may be reversed  
**512**



Double bend, first to the left  
Permitted variant: The  
symbol may be reversed  
**513**

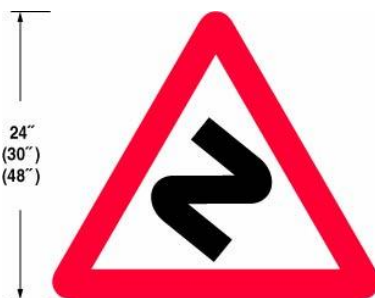

Series of bends  
**514**



Sharp deviation or route to the left  
(See Article 3)  
**515**

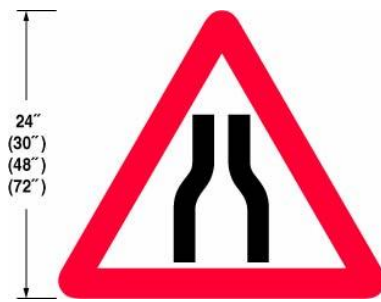

Road narrows on both sides  
**516**



Road narrows on offside  
Permitted variant: The symbol may be reversed  
**517**

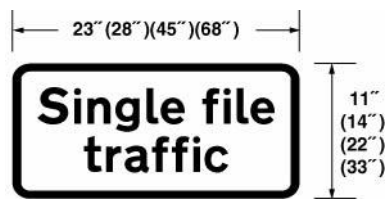

Convergence of traffic to single file  
Plate for use with signs in diagrams Nos. 516 and 517  
(See Article 8)  
**518**



**519**

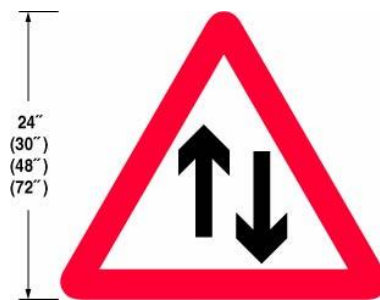

**520**



Two-way traffic across a one-way  
carriageway  
**522**

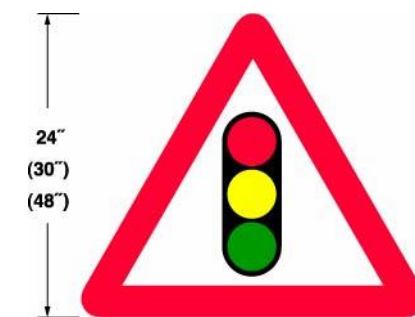

Traffic signals ahead  
**543**



Pedestrian crossing ahead  
**544**



Children  
**545**

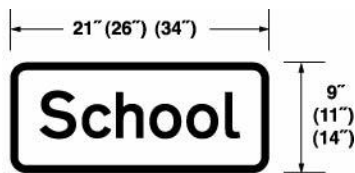

Plate for use with sign  
in diagram No. 545  
(See Article 8)  
**546**



Plate for use with sign in diagram Nos.  
543 or 544 in a case where a road hump  
is constructed and maintained in  
accordance with Regulation 4(4) of the  
[Highways \(Road Humps\) \(Jersey\)  
Regulations 2002](#)  
**547.5**



Cattle  
**548**



DIAGRAM **557.1**  
ROAD BUMP AHEAD



DIAGRAM 557.2



DIAGRAM 557.3



DIAGRAM 557.4



DIAGRAM 557.4 (Variant)



Low flying aircraft or sudden aircraft noise  
**558**

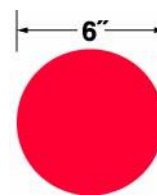

Hazard marker to indicate edge of carriageway or obstruction near that edge (See Article 6 and 7)  
**560**

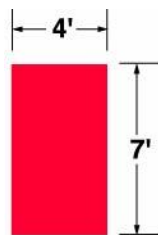

Same as No. 560 (See Article 6 and 7)  
**561**



Other danger (See Article 8)  
**562**



Plate indicating nature of other danger, for use with sign in diagram No. 562  
 Permitted variants: Surveying, Blasting, Gritting, Salting, Tree cutting, Road marking, Drain cleaning, Road cleaning, Fog, Ice, Frost damage or concealed entrance may be substituted for Accident  
 (See Article 3 and 8)

**563**



Road works  
 (See Article 8)

**564**

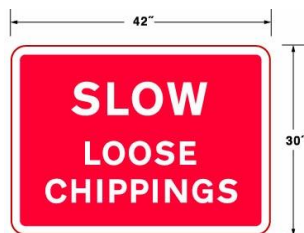

Permitted variants: Show wet tar, Temporary road surface, Traffic control ahead, Road ahead closed or Road closed may be substituted for Slow loose chippings  
 (See Article 8)

**565**



Permitted variant:  
 Right may be substituted for Left  
 (See Article 8)

**567**

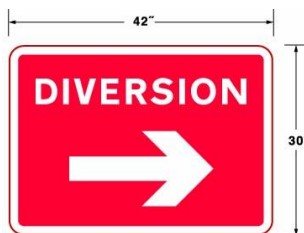

(See Articles 3 and 8)

**568**



Deviation of route to the left at or near road works or other temporary obstruction  
 (See Articles 3 and 8)

**569**

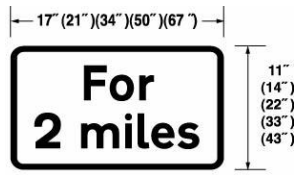

Distance over which hazard or prohibition extends  
 Plate for use with signs in diagrams  
 Nos. 514, 548, 558, 564, 614, 632  
**570**

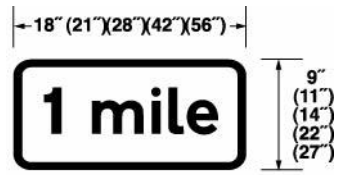

Distance to hazard  
 Plate for use with signs in diagrams  
 Nos. 504 to 509, 520, 543, 544 and 564  
 (See Articles 3 and 8)  
**571**

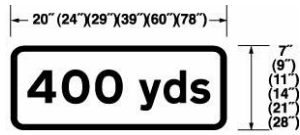

Same as No. 571 (See Articles 3 and 8)  
**572**

**PART 2<sup>30</sup>**

**REGULATORY SIGNS**

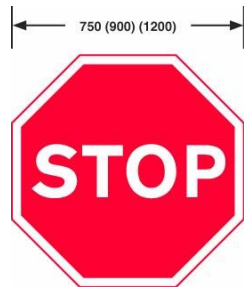

To indicate to vehicular traffic the requirements prescribed in Article 9.  
(See Articles 12 and 17)

**601.1**



(See Articles 8, 12 and 18)

**602**

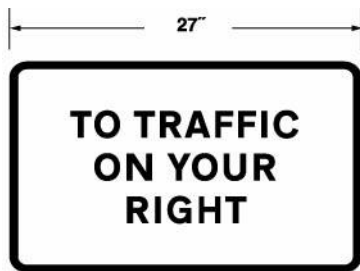
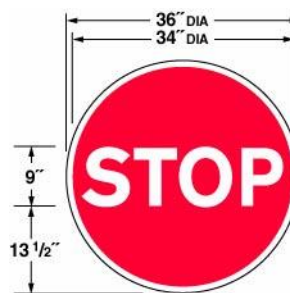

Plate for use with sign in diagram No. 602  
(See Articles 8, 12 and 18)

**602AJ**



(See Article 8)

**603**



(See Article 8)

**604**

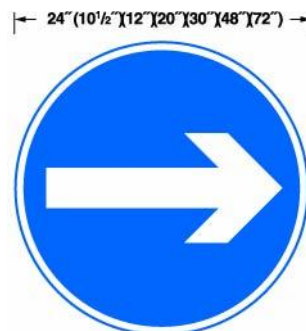

Proceed in direction indicated by arrow

(See Articles 3, 7 and 17)

**606**

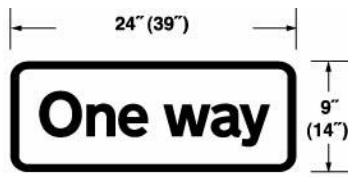

Plate for use with signs in diagrams Nos. 606 and 609 (See Articles 7 and 8)  
**607**

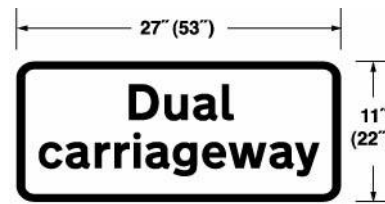

Plate for use with signs in diagrams Nos. 606, 609 and 610 (See Article 8)  
**608**

← 24" (10 1/2" | 12" | 20" | 30" | 48" | 72" ) →



Turn left ahead  
Permitted variant: The direction of the arrow may be reversed to indicate Turn right ahead (See Articles 7 and 17)  
**609**

← 24" (10 1/2" | 12" | 20" | 30" | 48" | 72" ) →



Keep left  
Permitted variant: The arrow may be pointed downwards to the right to indicate Keep right  
**610**

← 600mm (750mm)(900mm) →

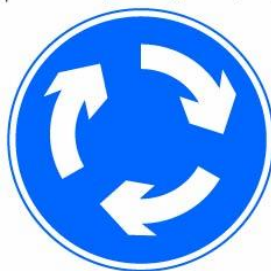

Vehicles entering the junction give priority to vehicles from the right at the transverse road marking shown in diagram 1003.3 associated with the sign or, if the line is not for the time being visible, at the road junction and proceed past the marking shown in diagram 1003.4 in the direction indicated by the arrows (See Article 8).  
**611.1**

← 10 1/2" (12' ) →



Pass either side  
**611**

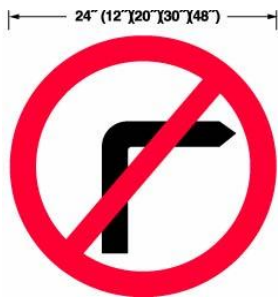

No right turn  
(See Articles 7 and 17)

**612**

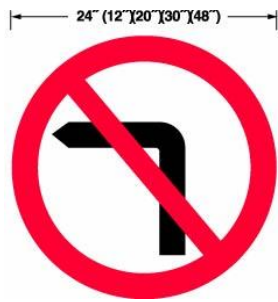

No left turn  
(See Articles 7 and 17)

**613**



No U turns  
(See Article 7)

**614**

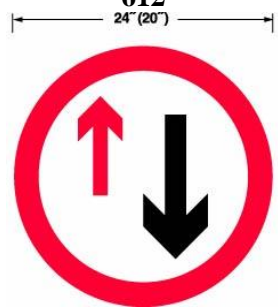

Priority to vehicles from  
the opposite direction  
(See Article 8)

**615**

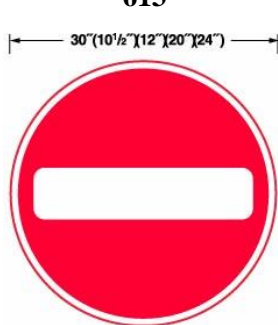

No entry  
(See Article 7 and 17)

**616**

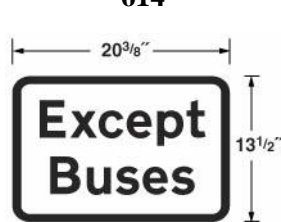
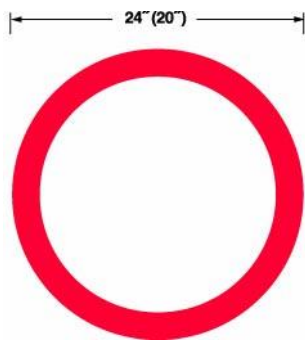

Plate for use with sign in  
diagrams Nos. 616 and  
629

**616A**



All vehicles prohibited in  
both directions  
(See Articles 7, 8 and 17)

**617**

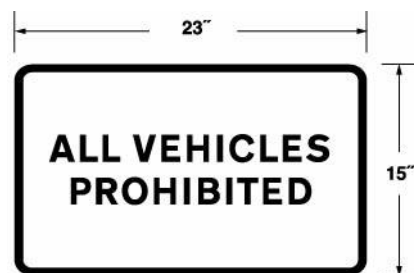

Plate for use with sign  
in diagram No. 617  
(See Articles 7 and 8)

**618J**



All motor vehicles prohibited  
(See Article 7)  
**619**

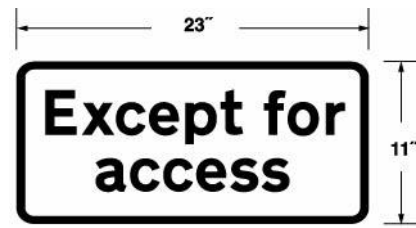
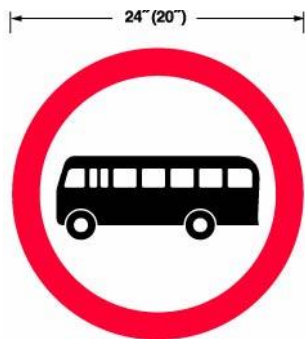
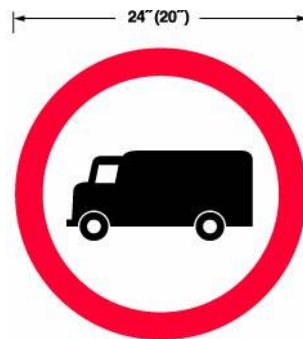

Plate for use with signs, in  
diagram Nos. 616, 619, 621 and 622  
(See Articles 7 and 8)  
**620**



Omnibuses and chars-à- banc prohibited  
(See Article 7)  
**621**



Heavy motor cars prohibited  
(See Article 7)  
**622**

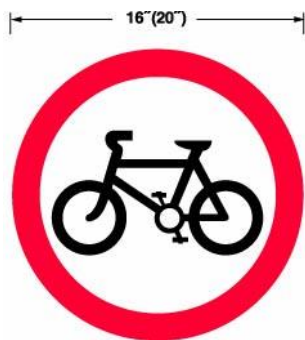

Cycling prohibited  
(See Article 7)  
**624**



Cycle Track  
(See Article 7)  
**625**



End of, or break in, cycle track  
(See Article 7)  
**625.4J**



Laden weight limit  
(See Articles 3 and 7)  
**626**



Plate for use with sign  
in diagram No. 626  
(See Articles 7 and 8)  
**627**

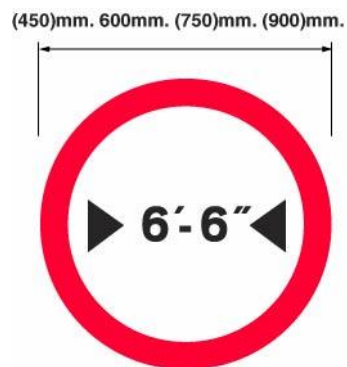

Vehicles exceeding width  
indicated prohibited  
(See Articles 3 and 7)  
**629**



Speed limit on  
particular roads  
(See Articles 3 and 7)  
**630**

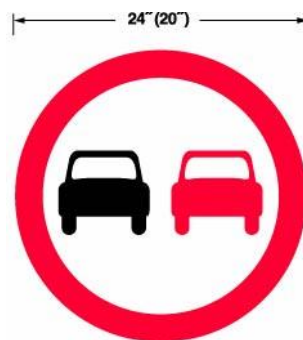

No overtaking  
(See Article 7)  
**632**



633



634



635

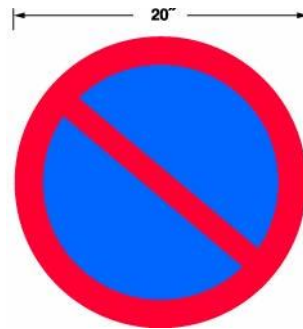

No waiting  
(See Article 7)

636

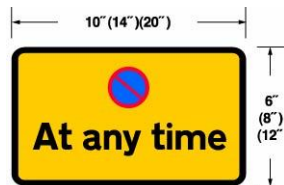

Plate showing continuous  
prohibition on waiting  
(See Article 7)

637

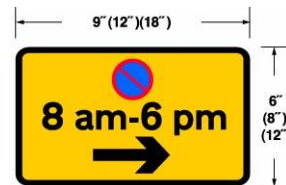

Plate showing hours during and  
direction in which waiting is prohibited  
(See Articles 3 and 7)

639

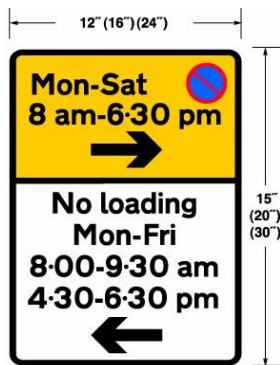

Plate showing (above) times during and direction in which waiting is prohibited and (below) times during and direction in which loading and unloading are prohibited  
(See Articles 3 and 7)  
**640**



Plate indicating alternate use, and times and conditions of use as unloading bay (above) and parking place (below)  
**640.1J**



Vehicles may be parked on the footway for the purposes of loading and unloading during the period indicated  
**640.2J**



Plate showing hours during which waiting is limited  
(See Articles 3 and 7)  
**641**

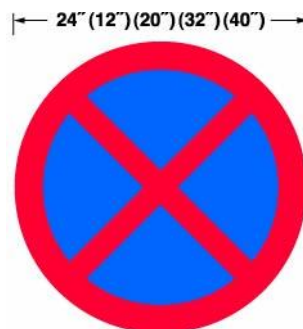

No stopping on carriageway  
(See Article 7)  
**642**

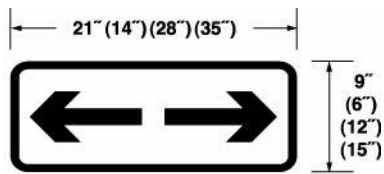

Plate for use with signs in diagrams Nos. 636 and 642 to indicate that the restriction or prohibition applies in both directions  
(See Articles 7 and 8)

**643**

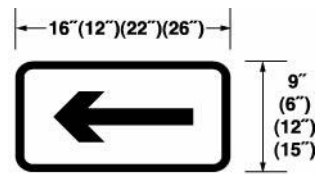

Plate for use with signs in diagrams Nos. 636 and 642 to indicate the direction in which the restriction or prohibition applies  
(See Articles 3, 7 and 8)

**644**

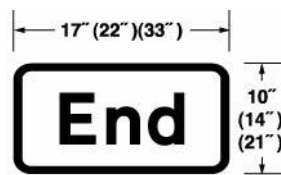

Plate showing end of a prohibition, for use with signs in diagram Nos. 614, 632 and 642.  
(See Articles 7 and 8)

**645**



Parking place reserved for disabled badge holders.  
(See Article 7)

**661**



Plate for use with sign in diagram No. 661 at parking places reserved for disabled badge holders, showing time limit and that display of parking disc is required.  
(See Article 8)

**661.1**



Plate for use with sign in diagram No. 801 at parking places in disc zones showing time limit and that display of parking disc is required.  
(See Articles 3, 7 and 8)

**662**

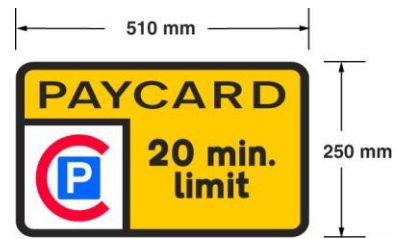
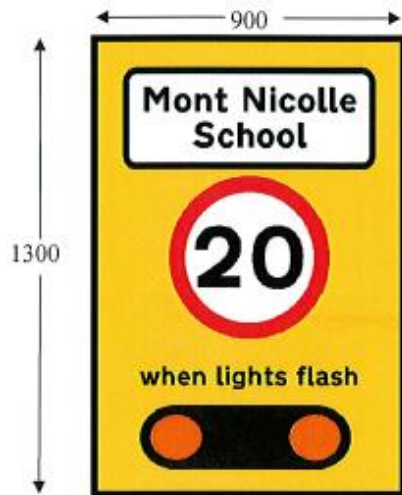

Plate for use with sign in diagram No. 801 at parking places in paying parking areas, showing time limit and that display of parking cards is required.  
(See Articles 3, 7 and 8)

**663**



Entrance to part-time speed limit at a school. Permitted variant: name of school may be varied.  
(See Articles 7 and 28A)

**670.1 J**

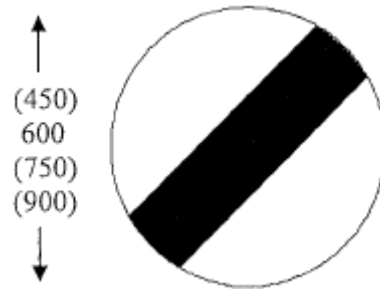

Island-wide speed limit applies  
**671**

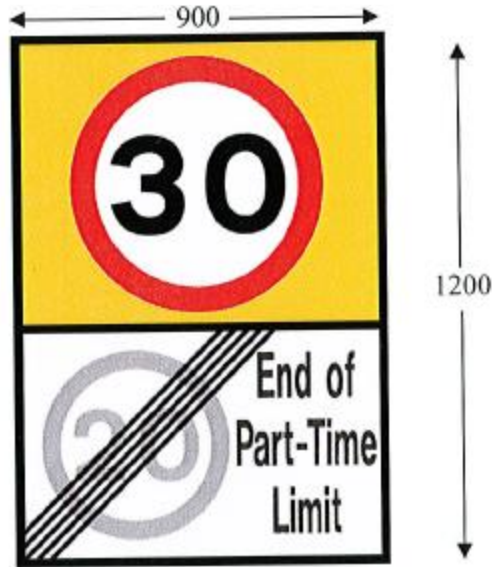

End of part-time speed limit zone at a school. Permitted variant: sign 671 may be used in place of the 30 mile an hour speed limit sign.

(See Articles 7 and 28A)

**671.1 J**

**PART 3<sup>31</sup>**

**DIRECTIONAL INFORMATORY SIGNS**



Route number of and next place of traffic importance on roads extending from a junction ahead

(See Articles 3, 4 and 7)

**704**



4"  
(3")  
(6")  
(9")

Same as No. 704  
(See Articles 3, 4 and 7)  
**705**



4"  
(3")  
(6")  
(8")

Direction of route and places. The route shown in brackets may be reached by proceeding in the direction indicated  
(See Articles 3, 4 and 7)

**713**



4"  
(3")  
(6")  
(8")

Route number of primary route with names of and distances in miles to places of traffic importance to which it leads. The bracketed name and figures indicate a place which branches off the primary route and the distance in miles to that place.

Permitted variant: On non-primary routes the legend and border shall be black and the background white  
(See Articles 3, 4 and 7)

**715**

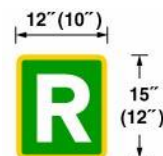

Indication that a primary route forms part of a ring road  
(See Article 7)

**717**

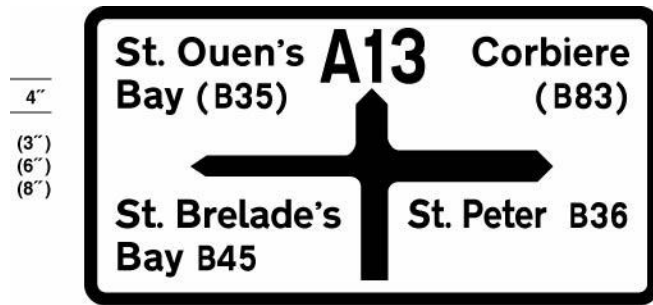

Same as No. 704. The relative importance of each road is shown by differing widths of the route symbol  
(See Articles 3, 4 and 7)

718

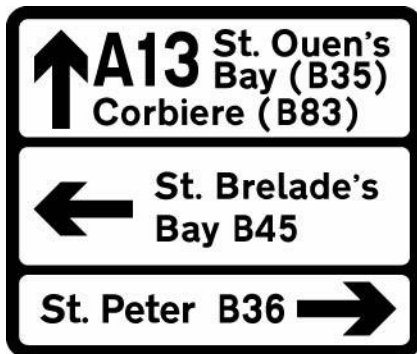

Same as No. 704  
(See Articles 3, 4 and 7)

720

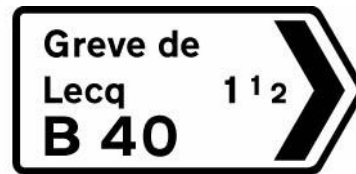

Direction of non-primary route and mileage to place named  
(See Articles 3, 4 and 7)

724



Alternative route from junction ahead to place named  
Permitted variants:  
Avoiding town centre, Coastal route or Avoiding road works may be substituted for Scenic route  
(See Articles 3 and 4)

727



Alternative direction to place named  
Permitted variants: Scenic route, Coastal route or Avoiding road works may be substituted for Avoiding town centre  
(See Articles 3 and 4)

728

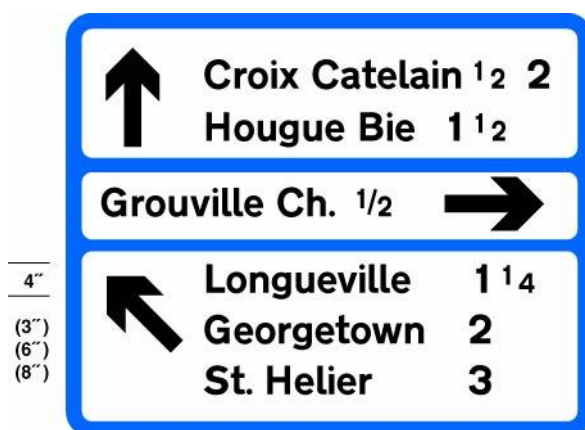

Direction from junction ahead to local places with mileage  
(See Articles 3 and 4)  
**730**



Direction from junction ahead to local places  
(See Articles 3 and 4)  
**731**



Direction to local places with mileage  
(See Articles 3 and 4)  
**732**



Direction to airport with mileage  
(See Articles 3 and 4)  
**733**



Direction to free car park  
Permitted variant: Free may be omitted  
(See Articles 3 and 4)  
**735**



Direction to toilets  
 Permitted variant: Ladies toilet or  
 Mens toilet may be substituted for  
 Toilets  
 (See Articles 3 and 4)  
**736**



Name of area  
 (See Articles 3 and 4)  
**737J**



Footpath direction sign with  
 distance to place indicated  
 (See Articles 3 and 4)  
**740**



Island cycle network route  
**741J**



Direction to Ancient Monument  
 (See Articles 3 and 4)  
**742**

**PART 4<sup>32</sup>**

**OTHER INFORMATORY SIGNS**

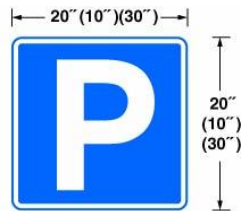

Parking place  
 Permitted variants: An arrow pointing horizontally left or right may be incorporated to indicate the entrance to an off-street car park; the plate in diagram No. 805 may be incorporated to indicate restrictions on the use of a parking place  
 (See Article 7)  
**801**

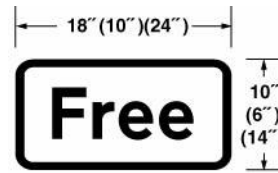
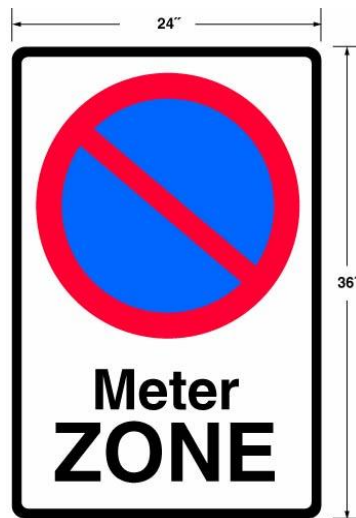

Plate for use with sign in diagram No. 801 indicating a free car park  
 Permitted variant: The legend may be varied to accord with any conditions imposed on the use of the car park or to indicate any restrictions on the use of the parking place  
 (See Articles 7 and 8)  
**805**



Entrance to controlled parking zone  
 Permitted variant: Controlled or Disc may be substituted for Meter  
 (See Article 7)  
**806**

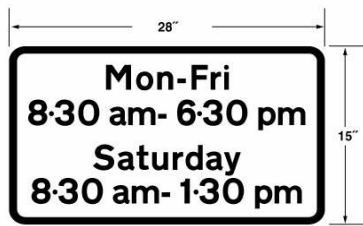
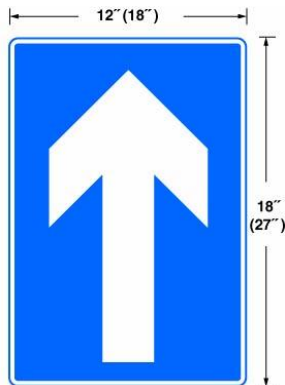

Plate for use with sign in diagram No. 806  
(See Articles 3, 7 and 8)  
**807**



Exit from controlled parking zone  
(See Article 7)  
**808**



One way traffic  
(See Article 7)  
**809**



One way street  
(See Articles 3 and 7)  
**810**

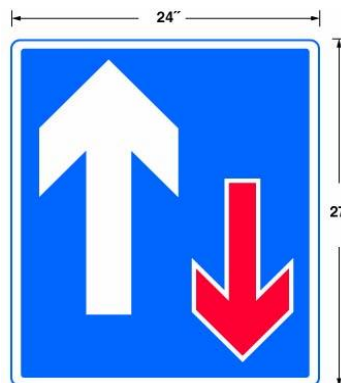

Priority over vehicles from the opposite direction  
(See Article 8)  
**811**

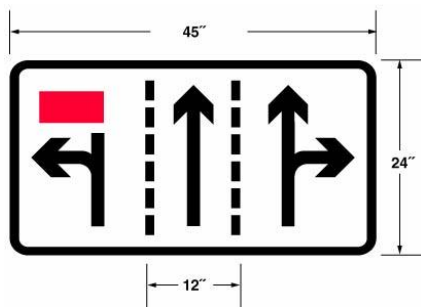

Nearside lane for traffic turning left only  
 Permitted variant: The centre lane may be omitted or the legend otherwise varied to accord with the circumstances  
 Note – The dimensions shown may be increased by 50% or by 100%.

**812**



**813**

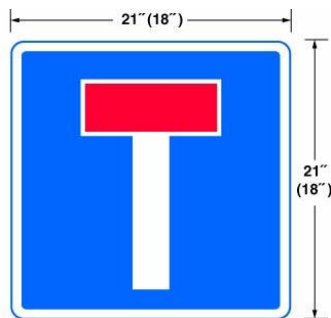

No through road  
**816**

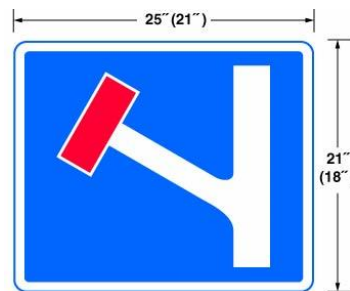

Advance sign indicated no through road  
 Permitted variant: The symbol may be reversed or otherwise varied to accord with the circumstances

**817**



**818**

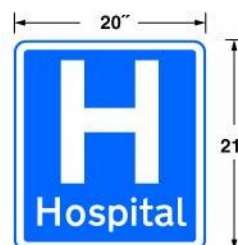

**827**



828J

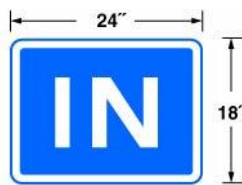

(See Article 8)  
833

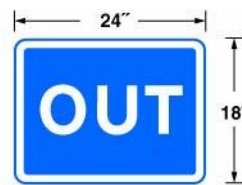

(See Article 8)  
834



(See Article 8)  
835



(See Article 8)  
836

**PART 5<sup>33</sup>**

**SIGNS FOR PEDAL CYCLE FACILITIES**

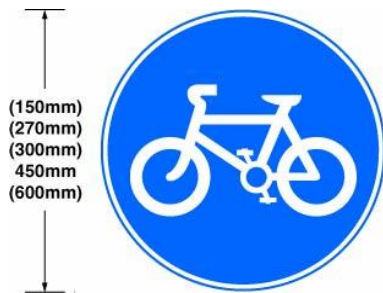

Route for use by pedal cycles only  
Use with diagram 1057  
**955**

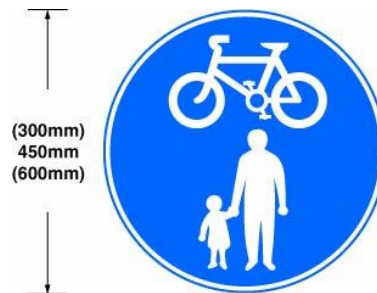

Shared cycle track and footpath  
Use with diagram 1057  
**956**

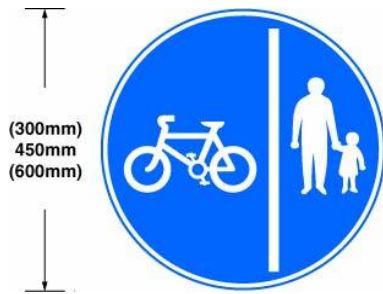

Shared cycle track and footpath separated by the marking shown in diagram 1049 or 1049.1 or by physical means. Use with diagrams 1049, 1049.1 and 1057

Permitted variant: symbols may be reversed in a mirror image

**957**

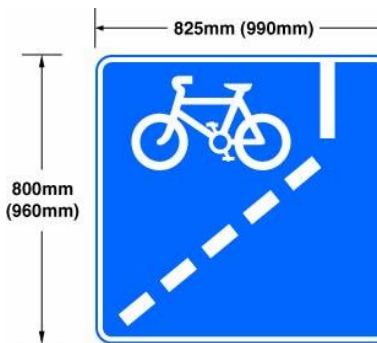

With-flow cycle lane ahead  
**958.1**



With-flow cycle lane  
Use with diagrams 1049 and 1057  
**959.1**



Contra-flow cycle lane  
Permitted variants: route symbols or the number of arrows or symbols indicating which lanes are open or closed may be varied  
Use with diagrams 1049 and 1057  
**960.1**



Cycle lane on road at junction ahead or cycle track crossing road  
Permitted variants: "lane" may be varied to "track", the arrow may be reversed, point upwards or be omitted.  
Where the arrow is omitted "lane" shall be varied to "lanes", "track" or "tracks".  
When the arrow is reversed the symbol must be reversed.  
**962.1**



Cycle lane with traffic proceeding from right  
(Sign for pedestrians)  
Permitted variants: "RIGHT" may be varied to "LEFT" or "BOTH WAYS".  
"LANE" may be varied to "LANES" or "TRACK".  
The symbol may be reversed.  
**963.1**



The end of a cycle lane or track  
**965**



Pedal cyclists to dismount at the end of, or at a break in a cycle lane or track  
**966**

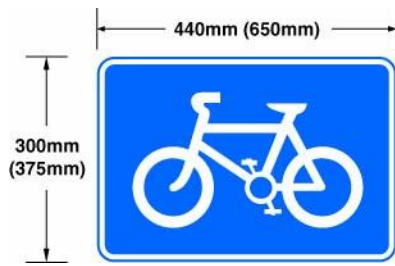

Route recommended for pedal cycles  
**967**



Parking place for pedal cycles  
**968**



Same as diagram 968  
**968.1**

**SCHEDULE 2<sup>34</sup>**

**MARKINGS ON THE ROAD**



Transverse line (stop line) to indicate position beyond which vehicular traffic must not proceed when required to stop by light signals  
(See Articles 11, 17 and 26)  
**1001**



Transverse line to indicate the position beyond which vehicular traffic must not proceed when required to stop by the sign shown in diagram No. 601.1  
(See Article 17)  
**1002.1**



Transverse marking necessary for giving effect to the requirement prescribed in Article 12(3)  
(See Articles 12 and 18)  
**1003**

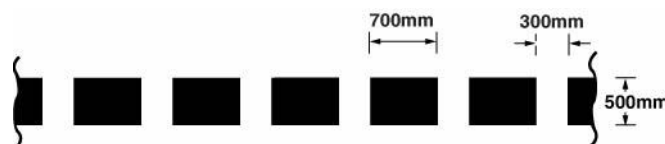

Transverse marking to indicate to vehicular traffic approaching a roundabout with a small central island or approaching a junction marked by signs conforming to that shown in diagram 611.1 the position at or immediately beyond which the said vehicles should give way to vehicular traffic circulating on the carriageway of the roundabout  
**1003.3**

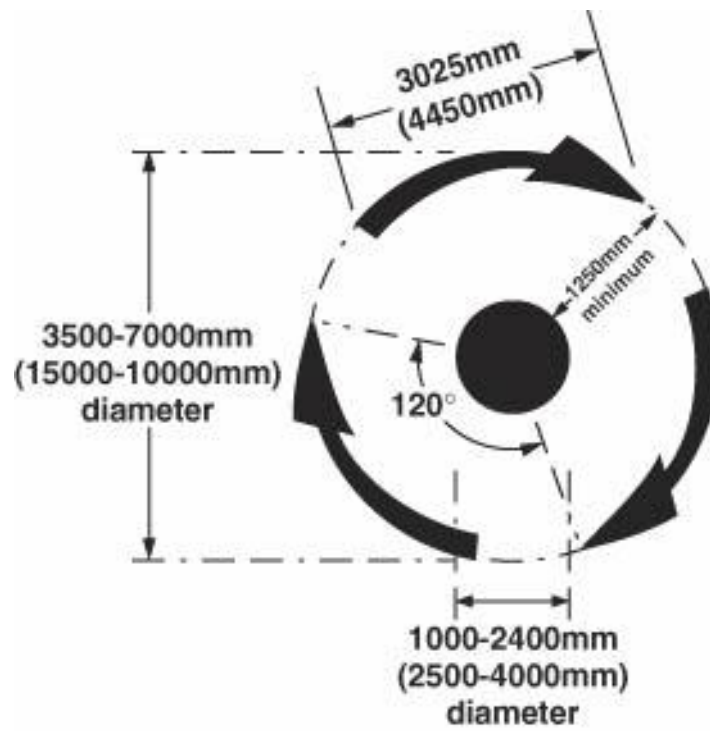

To indicate to vehicular traffic the direction of traffic flow at a junction marked by signs conforming to that shown in diagram 611.1  
**1003.4**

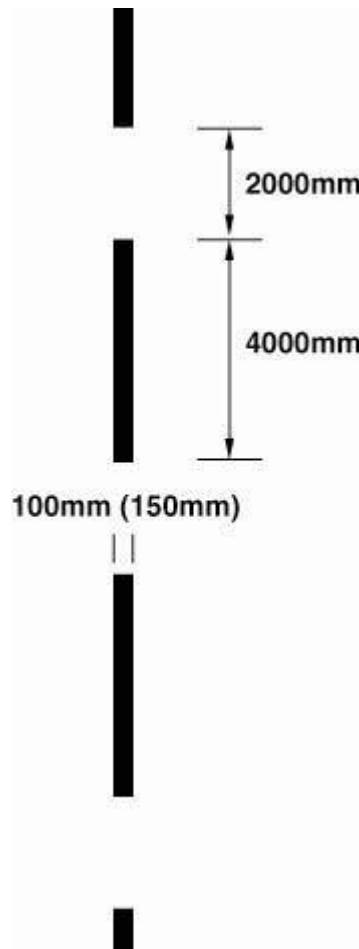

Vehicular traffic should not cross or straddle the line unless it is safe to do so, and when the line is used in conjunction with the sign in diagram 967 motor vehicles should not enter a cycle lane unless that lane is clear of pedal cycles  
Use with diagrams 967 and 1057

**1004**

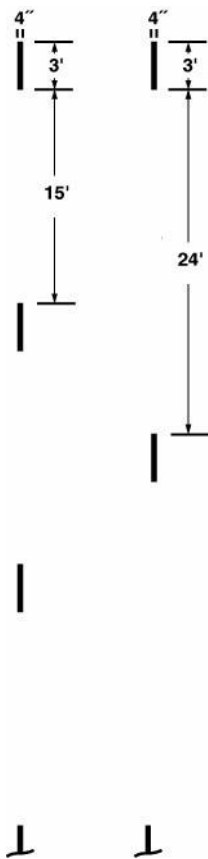

Alternative methods of marking a longitudinal line to indicate to vehicular traffic the division of the carriageway into traffic lanes  
**1005**

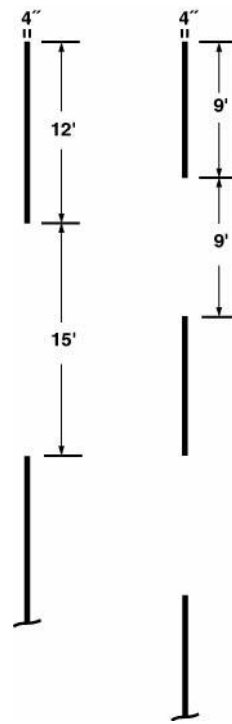

Alternative methods of marking a longitudinal line to indicate to vehicular traffic the centre of a four or six lane carriageway  
**1007**

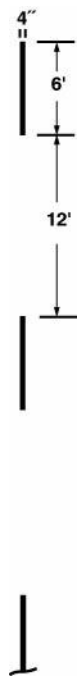

Longitudinal line to indicate to vehicular traffic the centre of a two lane carriageway  
**1008**

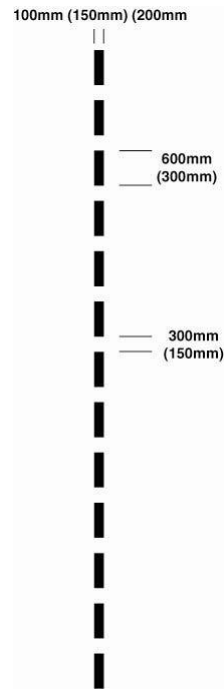

The start of a cycle lane  
**1009**

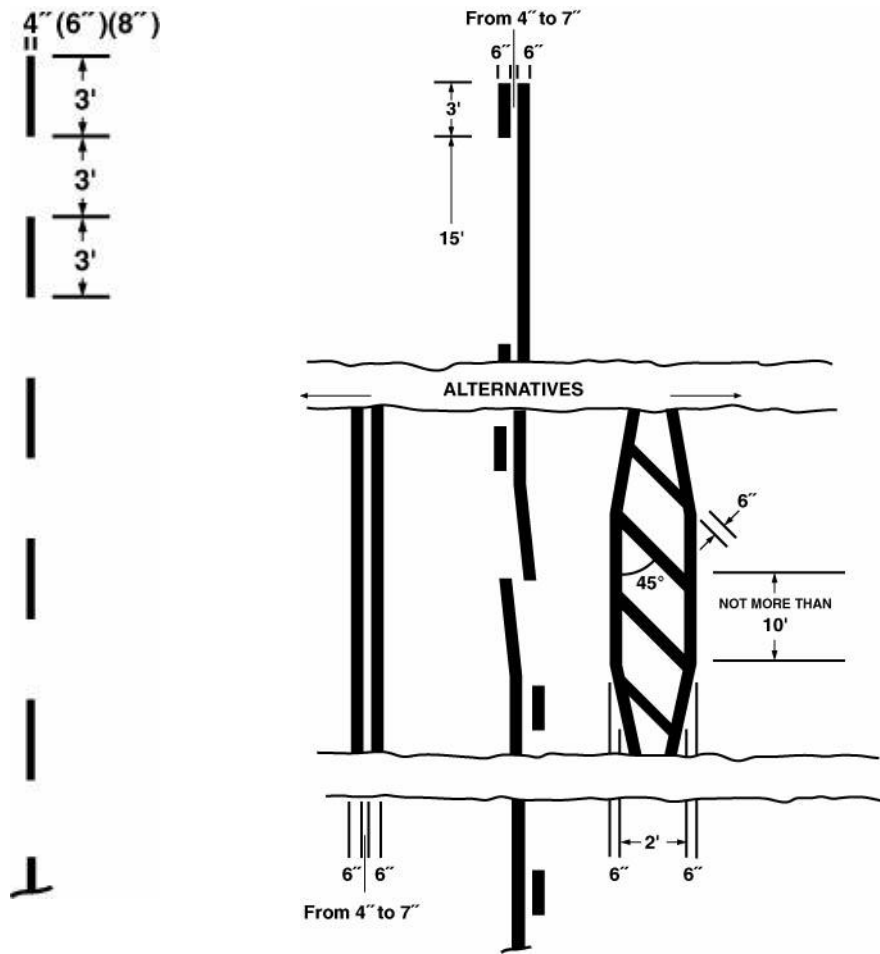

Longitudinal line to indicate to vehicular traffic the edge of the carriageway  
(See Article 11)  
**1010**

Longitudinal lines to indicate to vehicular traffic the requirements and the warning prescribed by Article 13  
(See Article 13)  
**1013**

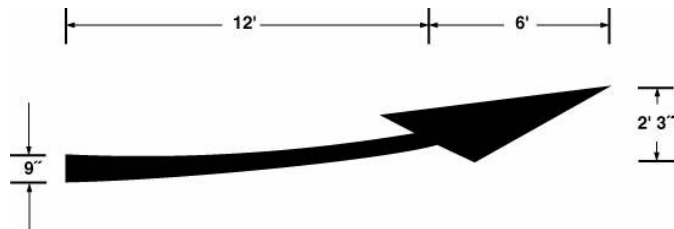

To warn vehicular traffic approaching a length of road on which are placed longitudinal lines shown in diagram No. 1013 of the need to keep to the left or nearside of both these lines  
**1014**



Marking to be placed on the side of a road to indicate that stopping by vehicular traffic on that side is prohibited along the length of the marking  
(See Articles 14 and 17)  
**1016J**



Longitudinal line to be placed on the side of a road to indicate that waiting by vehicular traffic on that side is prohibited along the length of the line  
(See Articles 14 and 17)  
**1017**

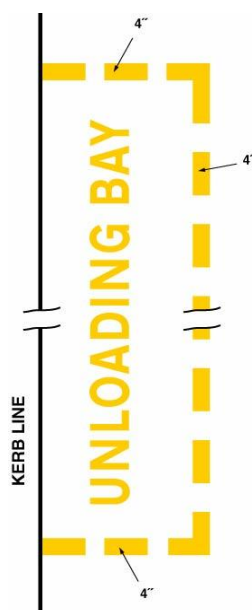

Marking to be placed on a part of a road to indicate an unloading bay  
(See Articles 14 and 17)

**1018J**

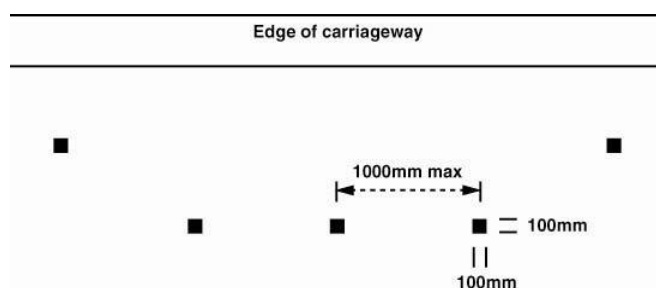

Marking to be placed on a footway to indicate the extent of a part-time zone for loading and unloading

Permitted variant: the marking may be white, silver or light grey

**1018.1J**

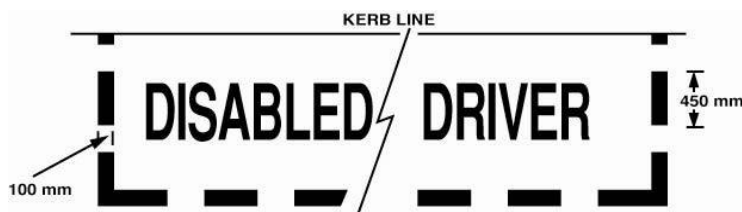

Marking to be laid near edge of carriageway to indicate limits of parking place reserved for disabled badge holders.

(See Articles 14 and 17)

**1021J**

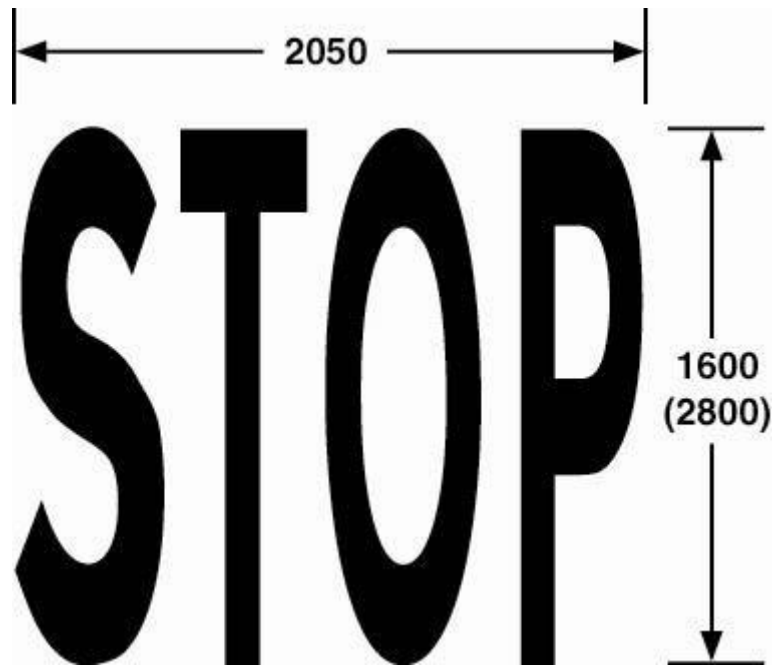

To indicate to vehicular traffic the approach to a road junction at or near which is placed the sign shown in diagram No. 601.1 and the road marking shown in diagram No. 1002.1  
**1022**



To indicate to vehicular traffic that entry into a road is prohibited  
(See Articles 11 and 17)  
**1022J**

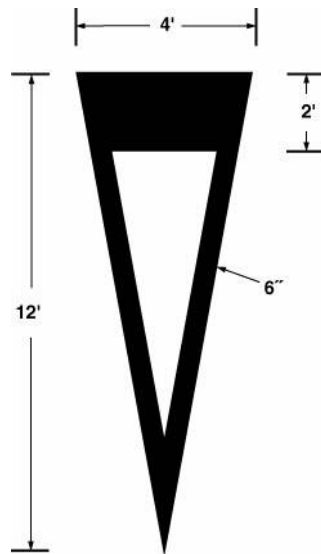

To indicate to vehicular traffic on a minor road the approach to a dangerous road junction  
(See Articles 14 and 17)

**1023**

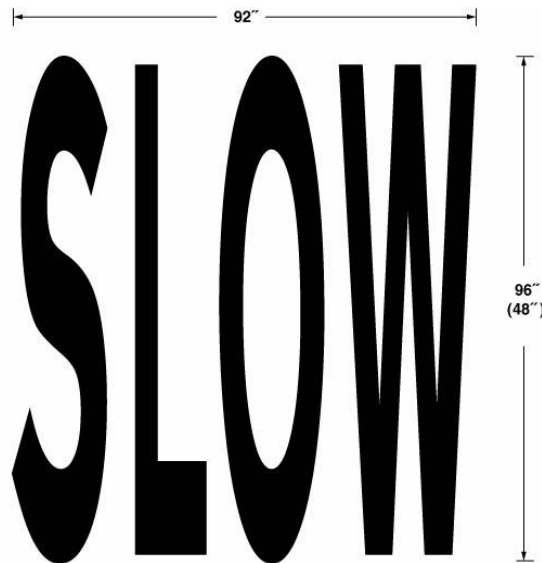

To indicate to vehicular traffic potential danger ahead  
and need to proceed with caution

Note In addition to the alternative height shown in brackets the dimensions of both height and width not shown in brackets may be increased by 50 per cent.

(See Article 11)

**1024**

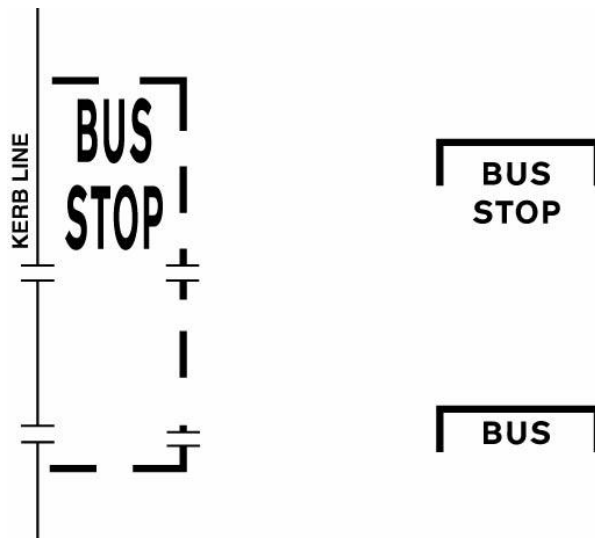

Alternative methods of indicating a bus stop  
**1025**



To indicate to vehicular traffic that part of the  
 carriageway which should be left clear of stationary vehicles  
**1026**

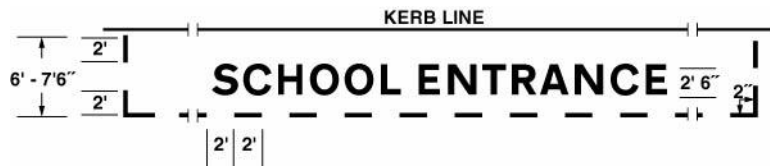

To indicate to vehicular traffic that part of the carriageway outside a school entrance which should be kept clear of stationary vehicles  
 Permitted variant: Ambulances may be substituted for School entrance to indicate that part of the carriageway (outside a hospital or similar institution) which should be kept clear for use by ambulances

**1027**

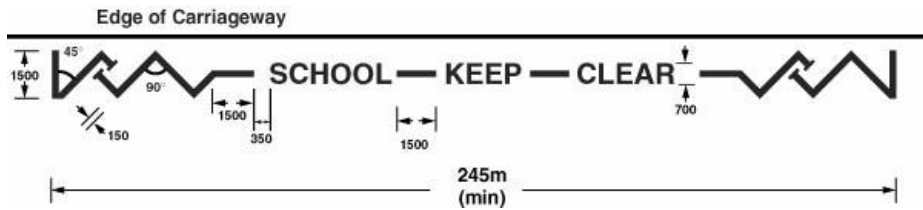

Alternative method of indicating to vehicular traffic a school entrance  
 Same as 1027

Note –

1. Except where indicated otherwise all dimensions are in millimetres.
2. The overall length of the marking may be increased in stages of 6 metres by inclusion of a complete zig-zag pattern each side of the wording.

**1027A**

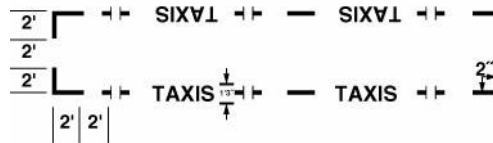
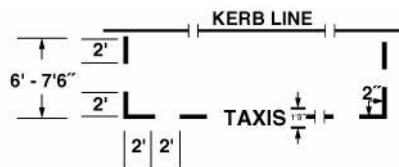

To indicate the limits of places at the side and in the middle of the road where taxis may stand

**1028**

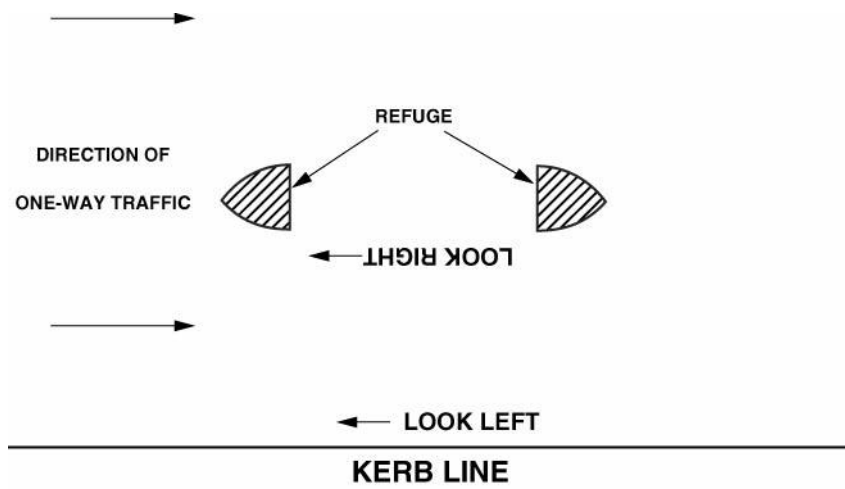

To warn pedestrians of approaching vehicular traffic in a one-way street  
(See Article 17)

**1029**

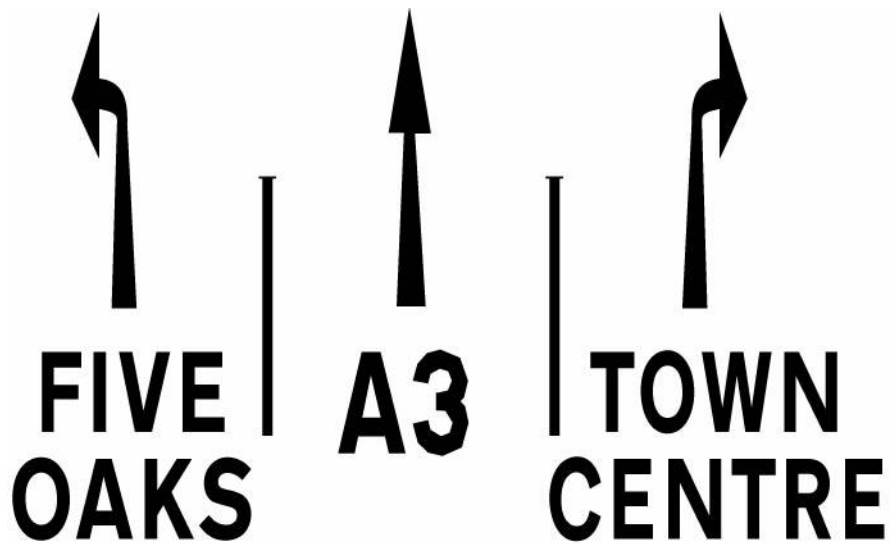

To indicate to vehicular traffic appropriate traffic lanes  
Permitted variant: The wording and marking

**1030**

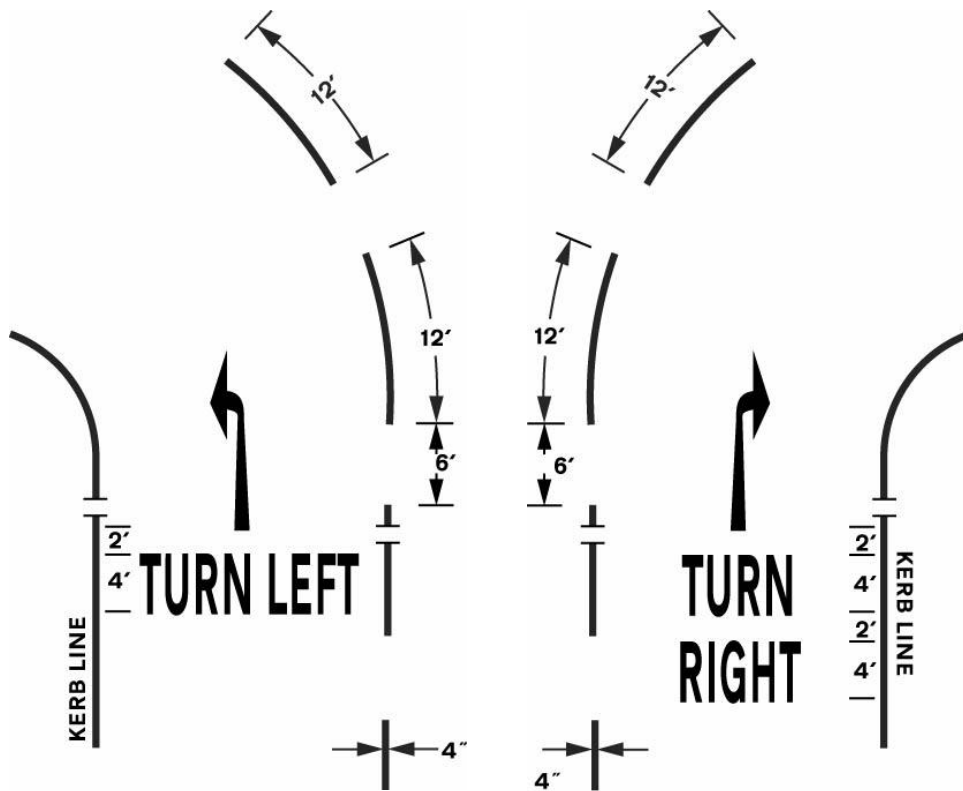

To indicate to vehicular traffic a compulsory turn  
(See Article 17)  
**1036**

Same as 1036  
(See Article 17)  
**1037**

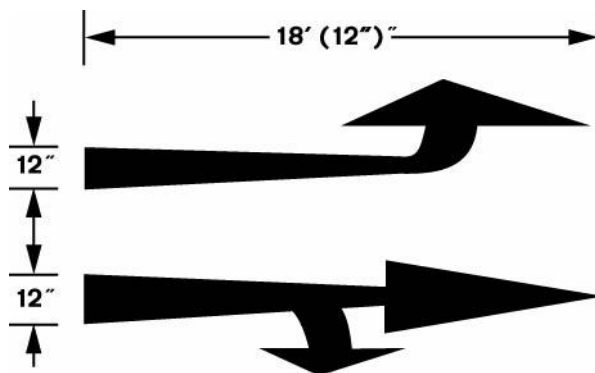

To indicate to vehicular traffic appropriate traffic lanes  
(See Article 11)  
**1038**

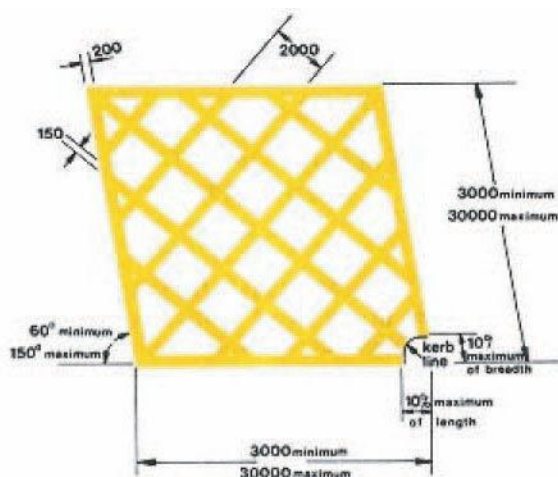

Alternative methods of marking an area of carriageway at a junction which vehicles must not enter in a manner which then causes any part of the vehicle to remain stationary within the marked area due to the presence of stationary vehicles

Notes –

1. All dimensions are in millimetres.
2. Any corner may be cut away in the manner shown in the bottom right hand corner of diagram No. 1043 and in the top right hand corner of diagram No. 1044 to a maximum of 10% of the length of the side affected to accommodate a corner kerb. Any corner shown as cut away may be completed in the manner of the other corners shown as not cut away.

**1043**

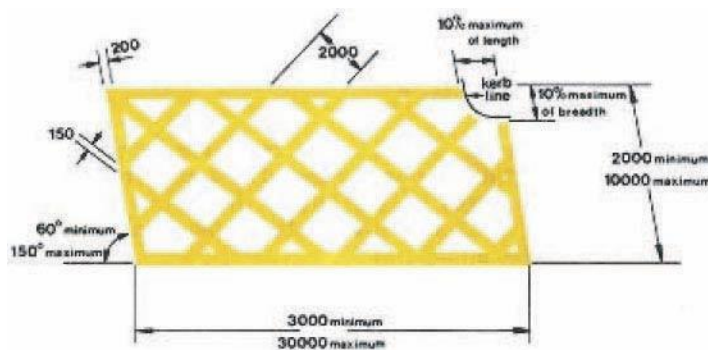

Same as 1043

**1044**

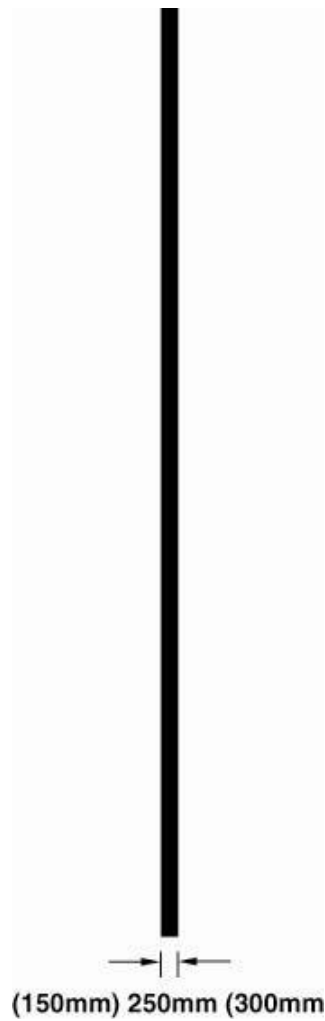

Boundary of a cycle lane. Where varied to 150mm wide and used in conjunction with the sign to diagram 625.2, the division of a route into that part reserved for pedal cycles and that part reserved for pedestrians  
Use with diagrams 957, 959, 959.1, 960.1, 1010, 1014, 1057 and 1058  
**1049**

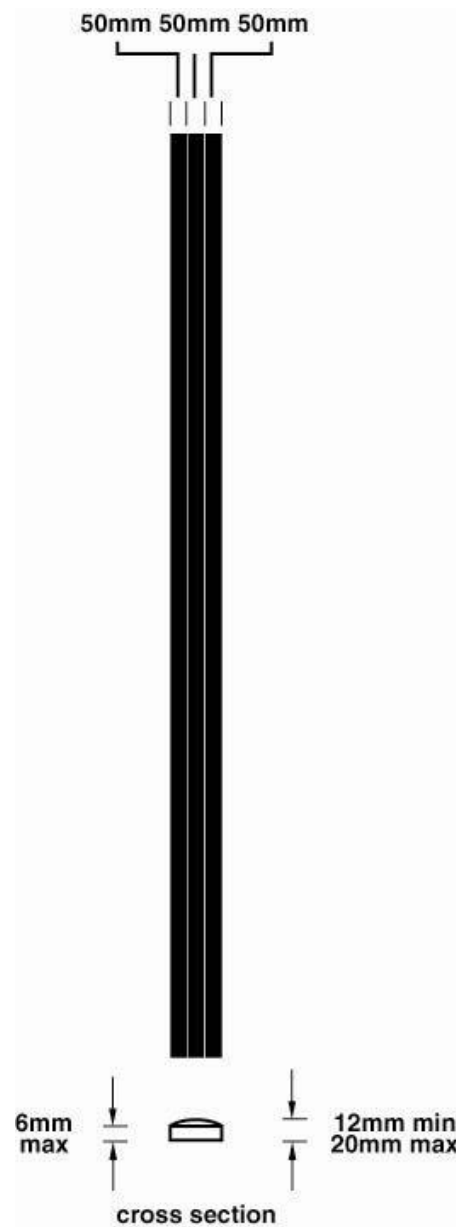

Division of a route into that part reserved for pedal cycles and that part reserved for pedestrians  
Use with diagrams 957, 1057 and 1058  
**1049.1**

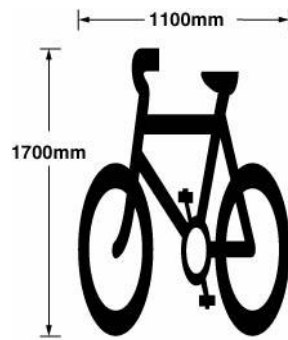

Cycle track or cycle lane  
**1057**

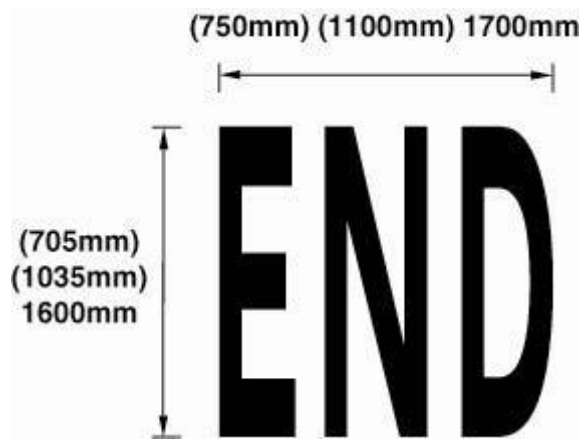

End of a cycle lane or track  
Use with diagrams 965, 1049, 1049.1 and 1057  
**1058**

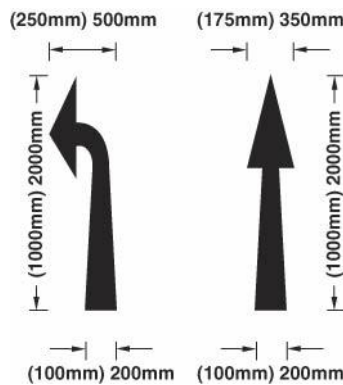

Directions in which pedal cycles should travel  
on a cycle lane or track  
Permitted variant: the arrow pointing to the left  
may be reversed to point to the right  
Use with diagram 1057  
**1059**

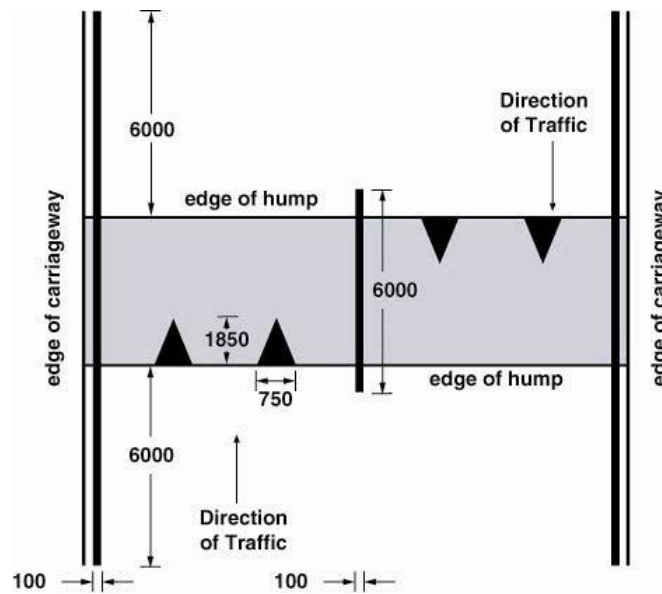

To indicate to vehicular traffic the presence of a round top road hump extending across the whole width of the carriageway  
 Permitted variants: the longitudinal line adjacent to the edge of the carriageway may be omitted when the longitudinal line in diagram No. 1017 is placed in the position of that line

on a one way road only one set of triangular markings will be required to face the approaching traffic and the centre line marking will be omitted

**1060**

All dimensions are in millimetres

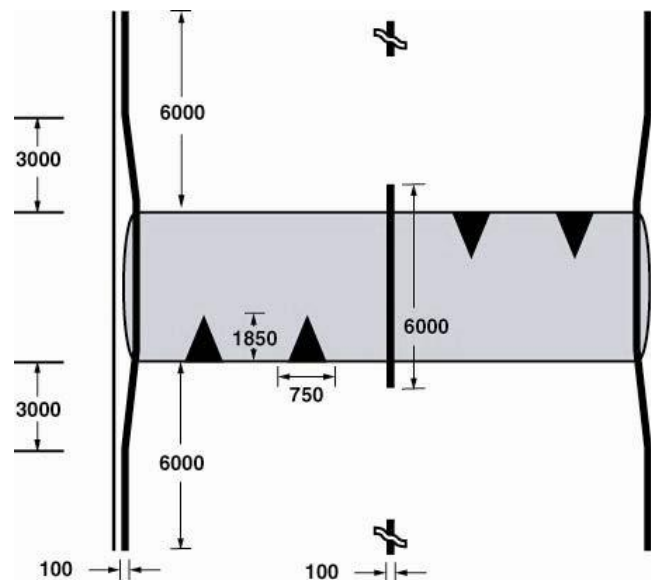

To indicate to vehicular traffic the presence of a round top road bump with tapered ends

Permitted variants: see Diagram No. 1060

**1060.1**

All dimensions are in millimetres

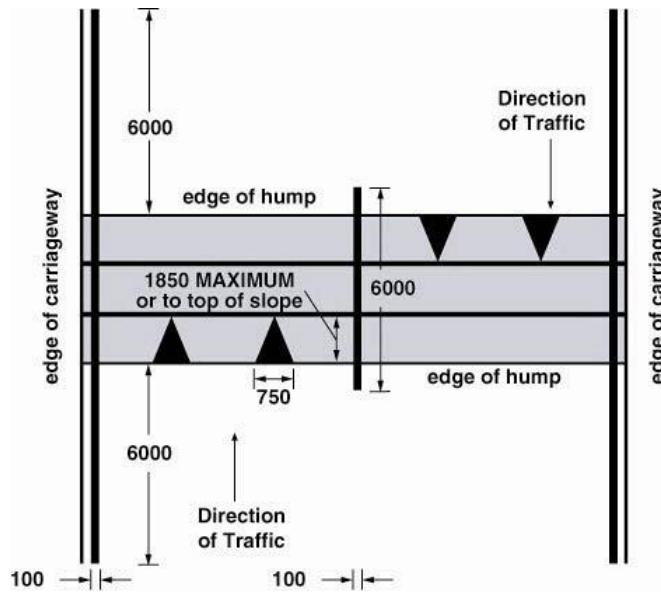

To indicate to vehicular traffic the presence of a flat top road hump extending across the whole width of a carriageway  
Permitted variants: see Diagram No. 1060

**1061**

All dimensions are in millimetres

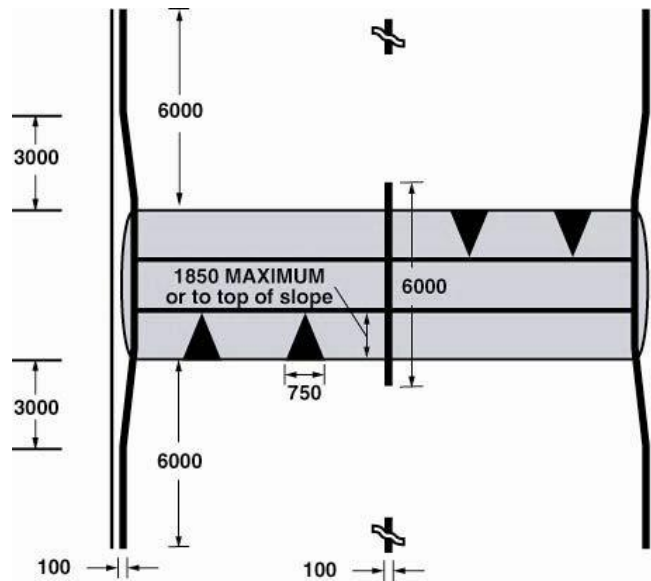

To indicate to vehicular traffic the presence of a flat-top road hump with tapered ends  
Permitted variants: see Diagram No. 1060

**1061.1**

All dimensions are in millimetres

**SCHEDULE 3<sup>35</sup>**

**INCORPORATION OF ARROW IN LIGHT SIGNALS FOR VEHICULAR TRAFFIC**

(See Article 24)

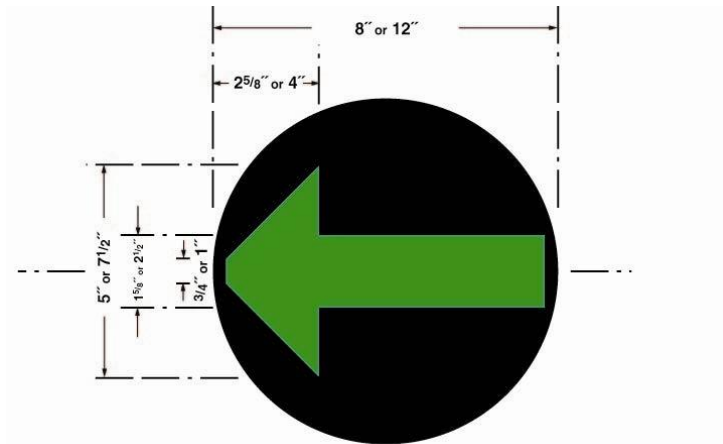

Details of lens showing green arrow

**1**

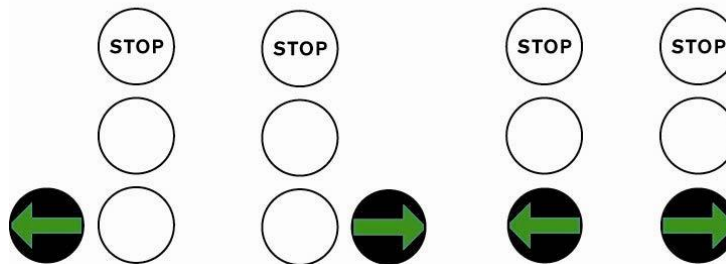

**2**

Methods of fitting green arrow to traffic light signals

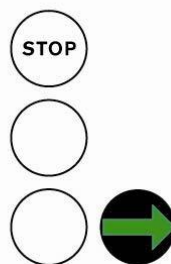

**3**

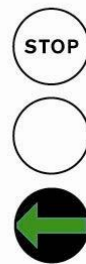

**4**

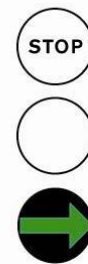

**5**

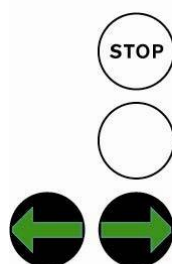

**6**

Methods of fitting green arrow to traffic light signals

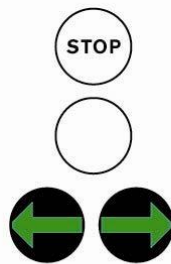

**7**

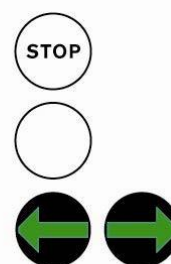

**8**

**SCHEDULE 4**

**PROPORTION AND FORM OF LETTERS, NUMERALS AND OTHER CHARACTERS**

(See Article 5)

**PART 1**

**TRANSPORT MEDIUM CAPITAL ALPHABET FOR USE ON SIGNS WITH A RED, BLUE OR GREEN BACKGROUND**

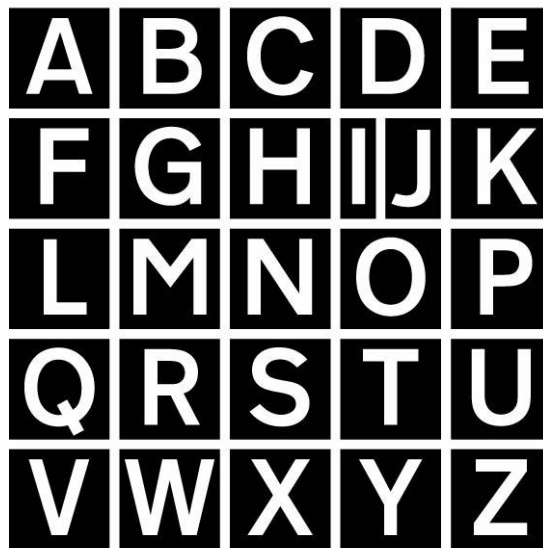

## PART 2

## TRANSPORT MEDIUM LOWER-CASE ALPHABET FOR USE ON SIGNS WITH A RED, BLUE OR GREEN BACKGROUND

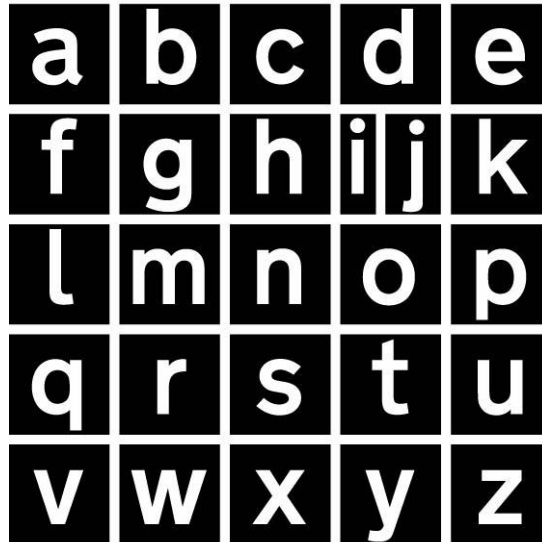

## PART 3

## TRANSPORT MEDIUM NUMERALS FOR USE ON SIGNS WITH A RED, BLUE OR GREEN BACKGROUND

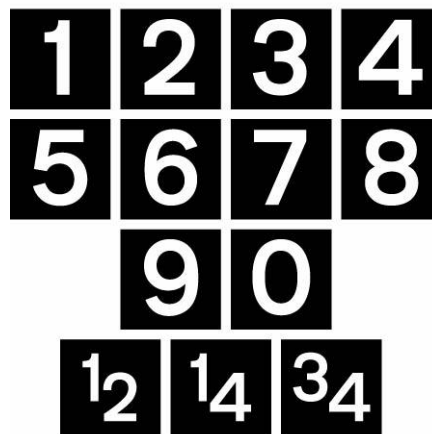

**PART 4**

**TRANSPORT MEDIUM OTHER CHARACTERS FOR USE ON SIGNS WITH A RED, BLUE OR GREEN BACKGROUND**

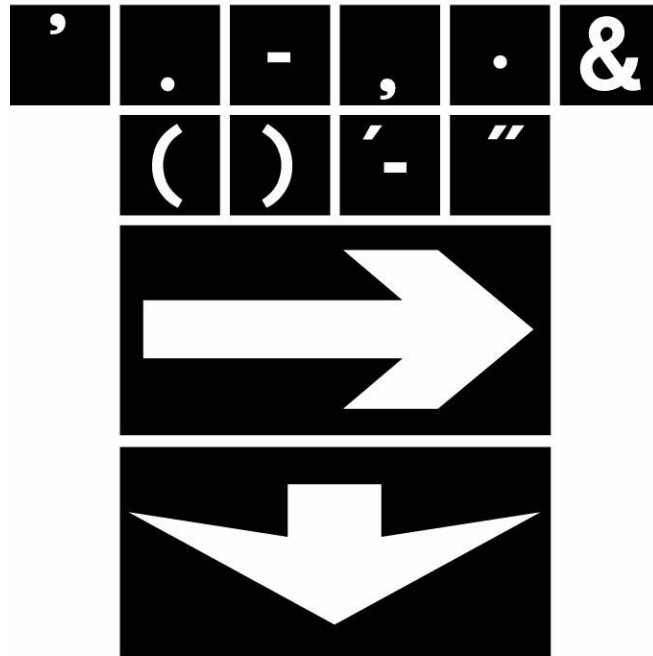

**PART 5**

**TRANSPORT HEAVY CAPITAL ALPHABET FOR USE ON SIGNS WITH A WHITE OR YELLOW BACKGROUND**

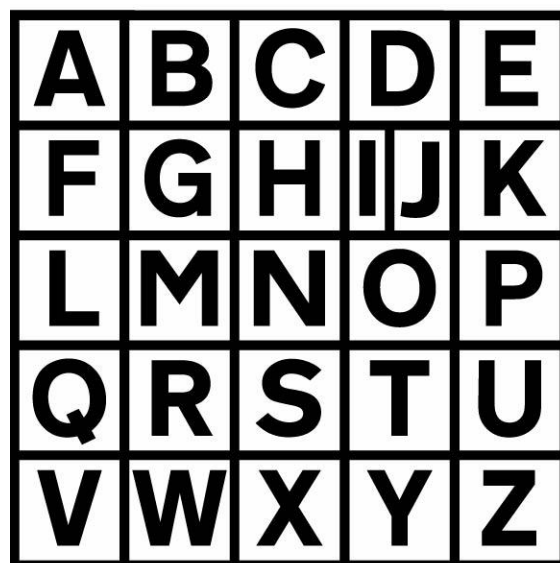

## PART 6

TRANSPORT HEAVY LOWER-CASE ALPHABET FOR USE ON SIGNS WITH A WHITE OR  
YELLOW BACKGROUND

<b>a</b>	<b>b</b>	<b>c</b>	<b>d</b>	<b>e</b>
<b>f</b>	<b>g</b>	<b>h</b>	<b>i j</b>	<b>k</b>
<b>l</b>	<b>m</b>	<b>n</b>	<b>o</b>	<b>p</b>
<b>q</b>	<b>r</b>	<b>s</b>	<b>t</b>	<b>u</b>
<b>v</b>	<b>w</b>	<b>x</b>	<b>y</b>	<b>z</b>

**PART 7**

**TRANSPORT HEAVY NUMERALS FOR USE ON SIGNS WITH A WHITE OR YELLOW BACKGROUND**

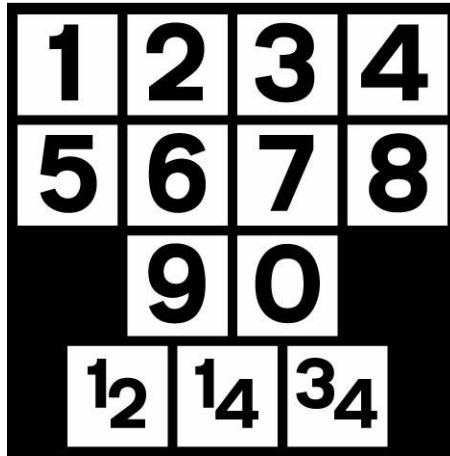

**PART 8**

**TRANSPORT HEAVY OTHER CHARACTERS FOR USE ON SIGNS WITH A WHITE OR YELLOW BACKGROUND**

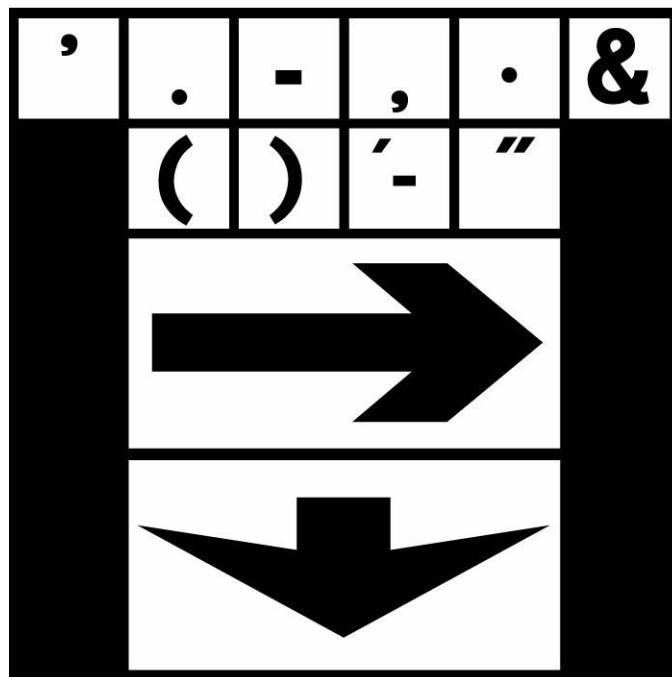

## ENDNOTES

### Table of Legislation History

Legislation	Year and No	Commencement
Traffic Signs (Jersey) Order 1968	<a href="#">R&amp;O.5114</a>	15 July 1968
Traffic Signs (Amendment) (Jersey) Order 1971	<a href="#">R&amp;O.5514</a>	21 April 1971
Traffic Signs (Amendment No. 2) (Jersey) Order 1972	<a href="#">R&amp;O.5684</a>	10 July 1972
Traffic Signs (Amendment No. 3) (Jersey) Order 1973	<a href="#">R&amp;O.5884</a>	1 December 1973
Traffic Signs (Amendment No. 4) (Jersey) Order 1974	<a href="#">R&amp;O.5948</a>	11 April 1974
Traffic Signs (Amendment No. 5) (Jersey) Order 1974	<a href="#">R&amp;O.6069</a>	1 November 1974
Traffic Signs (Amendment No. 6) (Jersey) Order 1976	<a href="#">R&amp;O.6339</a>	4 October 1976
Traffic Signs (Amendment No. 7) (Jersey) Order 1978	<a href="#">R&amp;O.6507</a>	13 March 1978
Traffic Signs (Amendment No. 8) (Jersey) Order 1982	<a href="#">R&amp;O.7034</a>	1 April 1982
Traffic Signs (Amendment No. 9) (Jersey) Order 1982	<a href="#">R&amp;O.7063</a>	1 July 1982
Traffic Signs (Amendment No. 10) (Jersey) Order 1983	<a href="#">R&amp;O.7212</a>	15 August 1983
Traffic Signs (Amendment No. 11) (Jersey) Order 1984	<a href="#">R&amp;O.7304</a>	23 August 1984
Traffic Signs (Amendment No. 12) (Jersey) Order 1987	<a href="#">R&amp;O.7631</a>	13 May 1987
Traffic Signs (Amendment No. 13) (Jersey) Order 1988	<a href="#">R&amp;O.7798</a>	1 December 1988
Traffic Signs (Amendment No. 14) (Jersey) Order 1991	<a href="#">R&amp;O.8167</a>	28 January 1991
Traffic Signs (Amendment No. 15) (Jersey) Order 1994	<a href="#">R&amp;O.8664</a>	24 March 1994
Traffic Signs (Amendment No. 16) (Jersey) Order 1998	<a href="#">R&amp;O.9301</a>	1 November 1998
States of Jersey (Amendments and Construction Provisions No. 7) (Jersey) Regulations 2005	<a href="#">R&amp;O.47/2005</a>	9 December 2005
States of Jersey (Transfer of Functions No. 1) (Home Affairs to Transport and Technical Services) (Jersey) Regulations 2006	<a href="#">R&amp;O.41/2006</a>	1 May 2006
Traffic Signs (Amendment No. 17) (Jersey) Order 2008	<a href="#">R&amp;O.102/2008</a>	22 August 2008

Legislation	Year and No	Commencement
States of Jersey (Transfer of Functions No. 8) (Miscellaneous Transfers) (Jersey) Regulations 2015	<a href="#">R&amp;O.158/2015</a>	1 January 2016
Road Traffic (Miscellaneous Amendments – Coastguard Vehicles) (Jersey) Order 2021	<a href="#">R&amp;O.66/2021</a>	17 May 2021

### Table of Renumbered Provisions

Original	Current
PART I	PART 1
PART II	PART 2
7(4A)	deleted by <a href="#">R&amp;O.9301</a> ; previously inserted by <a href="#">R&amp;O.7304</a>
8A	9
8B	10
PART III	PART 3
9	11
10	12
11	13
12	14
13	15
14	16
15	17
15(2A)	17(3)
(3)	(4)
(4)	(5)
(4A)	(6)
(5)	(7)
(6)	(8)
(7)	repealed by <a href="#">R&amp;O.9301</a> ; former paragraph inserted by <a href="#">R&amp;O.7304</a>
(8)	repealed by <a href="#">R&amp;O.9301</a> ; former paragraph inserted by <a href="#">R&amp;O.7304</a>
PART IV	PART 4
16	18
16(4)(aa)	18(4)(b)
(b)	(c)
17	19
18	20
19	21
20	22
21	23
22	24
23	25
24	26
24A	27

Original	Current
25	28
PART V	PART 5
26	29
26A	30
27	spent, omitted from this revised edition
28	spent, omitted from this revised edition
29	31
FIRST SCHEDULE	SCHEDULE 1
Part I	Part 1
Part II	Part 2
Part III	Part 3
Part IV	Part 4
SECOND SCHEDULE	SCHEDULE 2
THIRD SCHEDULE	SCHEDULE 3
FOURTH SCHEDULE	SCHEDULE 4
FIFTH SCHEDULE	spent, omitted from this revised edition

### Table of Endnote References

---

<sup>1</sup>	<i>This Order was repealed by the Road Traffic (Signs) (Jersey) Order 2026 on 22 April 2026</i>
<sup>2</sup>	<i>This Order has been amended by the States of Jersey (Amendments and Construction Provisions No. 7) (Jersey) Regulations 2005. The amendments replace all references to a Committee of the States of Jersey with a reference to a Minister of the States of Jersey, and remove and add defined terms appropriately, consequentially upon the move from a committee system of government to a ministerial system of government</i>
	<i>This Order has been further amended by the States of Jersey (Transfer of Functions No. 1) (Home Affairs to Transport and Technical Services)) (Jersey) Regulations 2006. The amendments give effect to the transfer of functions from the Minister for Home Affairs to the Minister for Transport and Technical Services</i>
<sup>3</sup> Article 1(1)	<i>amended by R&amp;O.7304, R&amp;O.7631, R&amp;O.9301, R&amp;O.102/2008, R&amp;O.158/2015</i>
<sup>4</sup> Article 3(1)	<i>amended by R&amp;O.6507, R&amp;O.7034, R&amp;O.7631, R&amp;O.8167, R&amp;O.9301</i>
<sup>5</sup> Article 6(1)	<i>amended by R&amp;O.7631</i>
<sup>6</sup> Article 7(1)	<i>amended by R&amp;O.6069, R&amp;O.6507, R&amp;O.7034, R&amp;O.7304, R&amp;O.8167, R&amp;O.102/2008</i>
<sup>7</sup> Article 8(3)	<i>amended by R&amp;O.7212, R&amp;O.7798</i>
<sup>8</sup> Article 8(8)	<i>amended by R&amp;O.5948, R&amp;O.6069, R&amp;O.7034, R&amp;O.7304, R&amp;O.8167, R&amp;O.9301</i>
<sup>9</sup> Article 9	<i>inserted by R&amp;O.7798</i>
<sup>10</sup> Article 10	<i>inserted by R&amp;O.9301</i>
<sup>11</sup> Article 11(2)	<i>substituted by R&amp;O.9301</i>
<sup>12</sup> Article 14(2)	<i>amended by R&amp;O.6339, R&amp;O.7034</i>

- 
- <sup>13</sup> Article 15(1) amended by R&O.7631
- <sup>14</sup> Article 15(3) inserted by R&O.7631, amended by R&O.8664,
- <sup>15</sup> Article 17(1) amended by R&O.6339, R&O.7034, R&O.7304
- <sup>16</sup> Article 17(3) inserted by R&O.7798
- <sup>17</sup> Article 17(6) inserted by R&O.7034
- <sup>18</sup> Article 18(1) amended by R&O.158/2015
- <sup>19</sup> Article 18(2) amended by R&O.158/2015
- <sup>20</sup> Article 18(3) amended by R&O.158/2015
- <sup>21</sup> Article 18(4) amended by R&O.7798
- <sup>22</sup> Article 24(1) substituted by R&O.5684
- <sup>23</sup> Article 27 inserted by R&O.5884
- <sup>24</sup> Article 28(1) amended by R&O.5514
- <sup>25</sup> Article 28A inserted by R&O.102/2008
- <sup>26</sup> Article 28A(1) editorial change, “2008” deleted, “2003” inserted instead
- <sup>27</sup> Article 29(3) amended by R&O.6339
- <sup>28</sup> Article 30 inserted by R&O.5884, heading substituted by R&O.66/2021, amended by R&O.66/2021
- <sup>29</sup> Schedule 1 Part 1 amended by R&O.7631; diagram 547.5 and indication below inserted by R&O.8664, editorial change, “carriageway” deleted, “carriageway” inserted instead
- <sup>30</sup> Schedule 1 Part 2 diagram 616A inserted by R&O.5948, diagram 616A amended by R&O.6507, diagram 629 inserted by R&O.6507, diagrams 661, 661.1, 662 inserted by R&O.7034, diagram 661.1 substituted by R&O.7063, diagram 611.1, 640.1 inserted by R&O.7212; diagrams 625 and 625.4J inserted by R&O.7304; diagram 601.1 inserted before diagram 602 by R&O.7798, diagram 640.1 substituted by R&O.7798; diagram 663 inserted by R&O.8167; diagrams 625 and 625.4J deleted by R&O.9301, diagram 640.2J inserted by R&O.9301; diagrams 670.1J, 671 and 671.1J added by R&O.102/2008
- <sup>31</sup> Schedule 1 Part 3 diagram 741J inserted by R&O.9301
- <sup>32</sup> Schedule 1 Part 4 diagram 804 inserted by R&O.6069, diagram 804 deleted by R&O.7034; diagram 810.3 inserted by R&O.7304; diagrams 801 and 805 amended by R&O.7798; diagram 810.3 deleted by R&O.9301
- <sup>33</sup> Schedule 1 Part 5 inserted by R&O.9301
- <sup>34</sup> Schedule 2 diagram 1027A inserted by R&O.6069, diagram 1043 and 1044 inserted by R&O.6339, diagram 1021J inserted by R&O.7034, diagram 1003.3, 1003.4 inserted by R&O.7212; diagrams 1049.1J and 1057 inserted by R&O.7304; diagram 1060 inserted by R&O.7631; diagram 1002.1 inserted after diagram 1001 by R&O.7798, diagram 1022 inserted after diagram 1021J by R&O.7798; diagram 1060 substituted and 1060.1, 1061 and 1061.1 inserted by R&O.8664; diagram 1004 substituted by R&O.9301, diagram 1009 inserted by R&O.9301, diagram 1010 amended by R&O.9301, diagram 1018.1J inserted by R&O.9301, diagram 1049 and 1049.1 substituted by R&O.9301, diagram 1057 amended by R&O.9301, diagrams 1058 and 1059 inserted by R&O.9301
- <sup>35</sup> Schedule 3 diagram 1 substituted by R&O.5684